

HydroTherm®



KN Series

**Gas-fired direct vent
Cast iron boilers**

Models KN-6, -10, -20 only
(HeatNet control firmware edition 2.45)

Control manual
Control adjustment and
Operation instructions

Also read and follow:
KN Series Gas Boiler
Installation & Operation
Instructions



WARNING This manual is intended only for use by a qualified heating installer/technician. Read and follow this manual, all supplements and related instructional information provided with the boiler. Install, start and service the boiler only in the sequence and methods given in these instructions. Failure to do so can result in severe personal injury, death or substantial property damage.

WARNING **Do not use the boiler during construction.** Construction dust and particulate, particularly drywall dust, will cause contamination of the burner, resulting in possible severe personal injury, death or substantial property damage. The boiler can only be operated with a dust-free air supply. Follow the instruction manual procedures to duct air to the boiler air intake. If the boiler has been contaminated by operation with contaminated air, follow the instruction manual guidelines to clean, repair or replace the boiler if necessary.

CAUTION Affix these instructions near to the boiler. Instruct the building owner to retain the instructions for future use by a qualified service technician, and to follow all guidelines in the User's Information Manual.

Hydrotherm KN-Series boilers — HeatNet™ control



KN
HeatNet
Electrical enclosure

Control overview

The **KN** HeatNet control monitors boiler temperature and limit circuit inputs, modulating boiler firing rate to meet demand. The control uses microprocessor electronics, watching time-average response from the system to anticipate how much heat the system needs. Coupled with the five-to-one turndown of the **KN** boiler, this results in maximum possible condensing-mode operation. The **KN** boiler will provide unmatched seasonal efficiency.

The HeatNet platform

HeatNet controls are designed to provide an integrated boiler management system on every boiler. The platform provides multiple levels of selectivity. HeatNet electronics can be operated as a simple single-boiler control, while still providing intelligent regulation of boiler firing rate to match system demand. With a few key strokes on the key pad, the HeatNet control can operate as a sophisticated multiple-boiler controller, using simple RJ45 cable interfacing between units. The control can even accept external control commands from building managements systems (Modbus standard, with optional bridge for BACnet or LonWorks) or 20-milliamp analog input from an external controller.

The control method used by the HeatNet control is based on digital communications, which eliminates the need for analog control signals. Analog signal inputs are supported, but a higher level of control precision, repeatability and feedback is gained with digital communications.

The HeatNet control can be versatile, providing for operation in multiple ways:

- As a stand-alone boiler, either modulating, two-stage or ON/OFF.
- As a boiler in a boiler network, using the on-board HeatNet protocol.
- As a member boiler in a boiler management system (either directly managed by BMS or managed by a MASTER HeatNet boiler that communicates with the BMS).
- As a member of a remotely-controlled boiler network (4 – 20-milliamp regulation).
- Setpoint can be determined by the HeatNet control or by a 4 – 20-milliamp input signal.
- Network boilers can be operated by override commands for increased versatility.

This manual is arranged so the instructions for each of the methods above is self-contained. See the Table of contents for selection and location.

PID response

The HeatNet control uses proportional-integral-derivative calculations to determine the response to boiler water temperature changes. This means it not only looks at how far away the water temperature is from the setpoint temperature, but how fast the temperature is changing and how it has responded over time. This ensures the boiler won't make sudden unnecessary changes in firing rate.

External limit monitoring & annunciation

In addition to controlling the boiler, the **KN** HeatNet control monitors external limits wired into the limit circuit connections. The control shuts down the boiler if a limit opens, and the digital display shows which limit failed. Monitored limits include high limit aquastat, low water cutoff, flow, ignition control fault, gas valve alarm and other optional or user-selectable limits.

Multiple boiler operation

The HeatNet control easily interfaces with other HeatNet controls. Multiple boiler operation using HeatNet protocol only requires RJ45 cables daisy-chained from boiler to boiler and a few key strokes setting up control behavior. The master boiler is automatically selected by connecting a sensor lead to its SYS/DHW HEADER sensor terminals. The HeatNet control recognizes the sensor and configures the boiler as the master. Other boilers only need to have an address assigned.

Among the advanced design features of the HeatNet control is the MOD-MAX setting. This limits the firing rate of all boilers to a pre-set maximum (70% by default). This means all of the boilers will be run at a very efficient level until all boilers are on. Only then can firing rate increase above this setting. Boiler rotation can be first-on/first-off, first-on/last-off, or true rotation (the HeatNet control monitors the total on time of all boilers, and rotates their usage so the total on time is the same for all).

Hydrotherm KN-Series boilers — HeatNet™ control



Electrical components

1. Electrical enclosure
2. Control panel — 4-line digital display and navigation buttons
3. Electrical connection panel
4. Electrical subpanel
5. Power connection strip for KN-6 and KN-10 — (120v/1/60)
6. Power connection strip for KN-20 — (208/230/240 VAC/1/60)
7. Flame safeguard (Honeywell)
8. VFD blower speed controller
9. On/off switch

KN
HeatNet
Electrical enclosure

The Mestek KN boiler — with HeatNet™ control



KN
HeatNet
Control panel

1 Stand-alone boilerpage 6

- Provide an external contact connected across J12A HEAT DEMAND terminals to start the boiler. (A MEMBER boiler in a network can also be activated by closing the circuit across HEAT DEMAND.)
- The boiler can operate based on its SUPPLY temperature, or can be operated by remote control from a 4-20mA source. And setpoint temperature can be controlled locally or by 4-20mA signal from a remote source.
- The boiler's T1/T2 terminals can be used to operate the boiler as two-stage (fired at minimum input or maximum input).
- The AA terminals can be used to fire the boiler as ON/OFF at maximum input.

2 Multiple boilers: HeatNet modulationpage 8

- The **KN** HeatNet control can control up to (16) **KN** boilers using built-in software and hardware.
- **KN** boilers come standard with HeatNet communications capability, and require only RJ45 HeatNet cables (or shielded wires) to connect between them.
- The header water temperature setpoint can be set by the master boiler or by a 4-20ma input from an external controller.
- Member boilers can override master boiler control if they receive a contact closure on the HEAT DEMAND terminals or the AA high fire terminals. In addition, the controls can be set up to allow priority override by a remote 4-20mA source.

3 Multiple boilers: BMS operationpage 13

- Combined BMS/HeatNet operation — This method uses the **KN** control's built-in communications capabilities to accept MODBUS protocol inputs from a building management system. The master boiler control sequences and modulates the boiler network to accomplish the demands from the building management system.
- Direct BMS control of all boilers — Each boiler can be operated directly by the BMS (each boiler will require an optional bridge if using BACnet or LONWORKS).
- Boiler setup is essentially the same as for method 2, with the exception that each boiler must be assigned both a HeatNet network address and an address for the MODBUS interface.
- An additional bridge is required to interface with systems using BACnet or LONWORKS protocol.
- The master boiler will take control and regulate the boiler network if signal from the BMS is lost or times out.

Contents

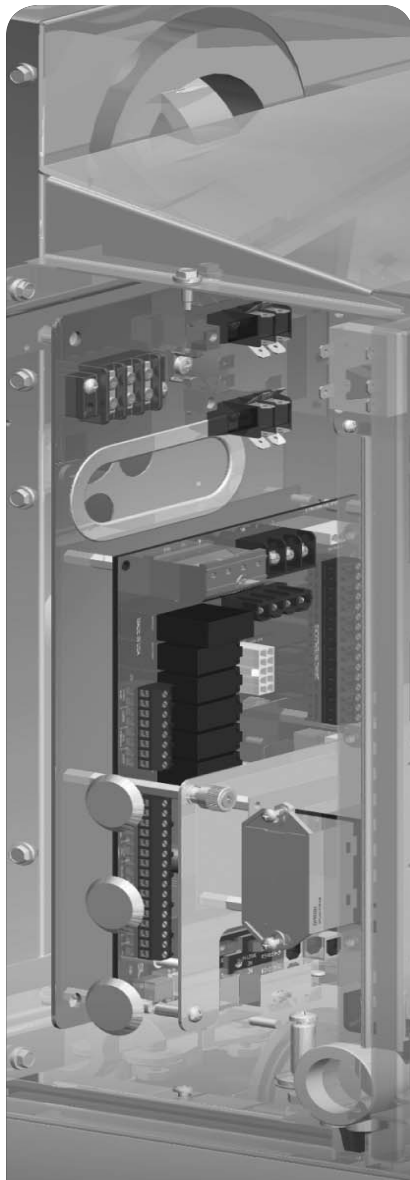

KN

HeatNet

Electrical connection
panel & subpanel

4 External 4-20ma controlpage 15

- 4-20mA/HeatNet combined operation — The master boiler can receive the 4-20mA modulation signal and control the other boilers.
- 4-20mA direct operation — Up to 5 boilers can be controlled by an external control that provides a 4-20ma input signal. The external controls must also activate each boiler by closing a contact across the boiler's 4-20ma Remote Enable contacts.
- Member boilers can override external boiler control if they receive a contact closure on the Heat Demand or any terminal higher priority than the 4-20mA (controls can be set up to make 4-20mA the highest priority if desired).

5 Control menus and adjustmentspage 24

- Operating parameters and control behaviors are set using the **KN** control's display/keypad interface.
- Refer to this section for the menu structure and explanations of the setup options.
- Table 7 — SETUP menus page 25
- Table 8 — ADVANCED SETUP menus page 28
- Table 9 — Setup menus — parameter explanations page 30

6 Wiringpage 24

- Wire the boilers as described in this section.

7 Boiler operation and status displaypage 24

- This section describes control start-up and operation.

8 Troubleshootingpage 44

- Table 10 — Status screen fault displays page 42
- Table 11 — Troubleshooting suggestions page 45

9 Setup worksheetpage 48

- Use this section to enter setup information.

1

Stand-alone boiler

WARNING **Electrical shock hazard** — Disconnect all electrical power sources to the boiler before making any electrical connections.

Label all wires prior to disconnection when servicing controls. Wiring errors can cause improper and dangerous operation! Verify proper operation after servicing.

Failure to comply with the above could result in severe personal injury, death or substantial property damage.

WARNING **Close the external manual gas valve on every boiler** before proceeding. DO NOT open any gas valve, or attempt to fire the boiler, until the boilers has been set up and verified following the instructions in the **KN** Series Gas Boiler Installation & Operating Instructions.

Failure to comply could cause a boiler failure, leading to possible severe personal injury, death or substantial property damage.

NOTICE The electrical connections to this boiler must be made in accordance with all applicable local codes and the latest revision of the National Electrical Code, ANSI /NFPA-70. Installation should also conform to CSA C22.1 Canadian Electrical Code Part I if installed in Canada. Install a separate 120 volt 15 amp circuit for the boiler. A properly rated shut-off switch should be located at the boiler. The boiler must be grounded in accordance with the authority having jurisdiction, or if none, the latest revision of the National Electrical Code, ANSI/NFPA-70.

Line voltage field wiring of any controls or other devices must use copper conductors with a minimum size of #14 awg. Use appropriate wiring materials for units installed outdoors.

Control setup sequence

CAUTION Install the boilers according to the **KN** Series Gas Boiler Installation & Operating Instructions before attempting to set up the control system.

1. Close the external gas valve.
2. Wire the boiler following the guidelines in this manual.
3. Attach sensors as required, including a HEADER sensor if needed for primary/secondary circuits or DHW tank heating.
4. Set the boiler control parameters using its display/keypad.

Wiring

1. See page 16 for wiring information and wiring diagrams.
2. Note that the boiler can be wired for override operation. The wiring section provides information on override priorities and options.
3. The boiler can be activated by the HEAT DEMAND input, and allowed to modulate based on the HeatNet control. It can also be activated by either:
 - ON/OFF full input operation by closing the AA terminals.
 - Operation via remote 4-20mA signal by closing the 4-20mA ENABLE terminals and providing the 4-20mA signal.
 - Two-stage fired by using the T1 and T2 terminals. Closing one of these brings the boiler on at MIN firing rate. Closing the other brings the boiler to MAX input.

Set control parameters

NOTICE Before turning boilers on to set parameters, disconnect all call for heat wiring at the electrical connection boards. This will prevent the boiler from attempting to cycle during the setup process.

1. See Table 1 for a list of parameters that should be set for a stand-alone boiler.
2. See “Control menus and adjustments,” beginning on page 24 for a complete list of control parameters and explanations (Table 7, page 25 and Table 8, page 28).
3. Carefully read the parameter explanations in Table 9, page 30.
4. When adjusting the limit band, operating limit (OP LIMIT), local setpoint (LOC SETPOINT) or system/header (SYS/DHW HEADER) setpoint, make sure the operating temperature bands do not overlap or cause potential for nuisance cycling.
5. System clock — Set the system clock to ensure the time stamps will be accurate in the data logs.
6. Turn on the power to the boiler and set the on/off switch to ON as you set its parameters.
7. Use the boiler’s keypad to enter the parameters as described on page 24.
8. After setting a boiler’s parameters, turn off the power to the boiler until you are ready to start the boiler up following the Boiler manual instructions.

Start up boiler

1. Follow all instructions in the **KN** Series Gas Boiler Installation & Operating Instructions to start up the boiler and verify operation.
2. After setting up the boiler per the **KN** I & OM Instructions, you can set MIN, MAX and IGNITION firing rates using the CALIBRATION procedure in this manual.

1

Stand-alone boiler (cont.)**Table 1** Control parameters — stand-alone boiler

Parameter	Requirement
BOILERS	
HEAT BAND	Set
SETPOINTS	
LOCAL SETPT.....	Set if control will regulate boiler supply temp
SYSTEM SETPT.....	Set if control will regulate header or DHW tank temp (requires header sensor)
OPERATE LIMIT	Set
OP LIMIT BAND	Set
SETPT SOURCE.....	Specify AUTO or 4-20mA remote control (AUTO uses the HeatNet control setup values for setpoint temperature; 4-20mA uses a 4-20mA signal to determine setpoint temperature as described in the parameters tables)
OUTDOOR RESET, IF USED	
OA RESET	Enable if used
WARM WEATHER SD.....	Enable if used
WWS SETPOINT.....	Set if used
OA SETPTS	Set if used (requires outdoor sensor)
SYSTEM PUMP	Applies ONLY if the control will cycle a system pump as well as the boiler pump
POST PRG TIME.....	Set or keep default
ALWAYS ENABLE	Enable if desired
SUMMER PUMP JOG	Enable if desired
LOCAL PUMP	Settings for boiler pump
DELTA TEMP ENABLE	Enable if desired (requires installing a return water temp sensor)
DELTA TEMP.....	Set value if enabled
POST PRG TIME.....	Set or keep default
ALWAYS ENABLED.....	Enable if desired
PUMP/VALVE OPTION	Enable constant pump if desired
FLOW PROVE	Enable if used (connect flow switch)
NIGHT SETBACK	Set if desired
OPTIONS (all)	Set
AUX FUNCTIONS	
COMBUST AIR DAMPER	Select IN USE = YES to enable; select proof time or keep default (connect wires to damper and end switch)
ALARM SILENCE	Enable remote alarm silence if desired (connect terminals to remote switch)
FAILSAFE MODES	Enable LOW TEMP if desired for freeze protection; set temp as desired
SYSTEM CLOCK	Set to ensure accuracy of time stamping
SENSORS	Select type or accept defaults; make sure installed sensors are listed and are the correct type
4-20mA INPUT	Set values for 4-20mA parameters if using either as primary control source or as an override
PASSWORD	Set if desired
COMMUNICATIONS	Set if desired
LOAD DEFAULTS	Restore defaults if desired
SYSTEM	Load firmware if necessary to bring up to date

2

Multiple boilers: HeatNet modulation

WARNING **Electrical shock hazard** — Disconnect all electrical power sources to the boiler before making any electrical connections.

Label all wires prior to disconnection when servicing controls. Wiring errors can cause improper and dangerous operation! Verify proper operation after servicing.

Failure to comply with the above could result in severe personal injury, death or substantial property damage.

NOTICE The electrical connections to this boiler must be made in accordance with all applicable local codes and the latest revision of the National Electrical Code, ANSI /NFPA-70. Installation should also conform to CSA C22.1 Canadian Electrical Code Part I if installed in Canada. Install a separate 120 volt 15 amp circuit for the boiler for KN-6 and KN-10 (208/230/240 VAC/1/60, 20-amp for KN-20). A properly rated shut-off switch should be located at the boiler. The boiler must be grounded in accordance with the authority having jurisdiction, or if none, the latest revision of the National Electrical Code, ANSI/NFPA-70.

Line voltage field wiring of any controls or other devices must use copper conductors with a minimum size of #14 awg. Use appropriate wiring materials for units installed outdoors.

Set termination DIP switches

1. The HeatNet network needs to recognize the beginning and end of the network. This requires setting the four DIP switches on each boiler's electrical connection board.
2. See Figure 1 for location of the switches.
3. See Table 2 for required settings. The table gives settings for HeatNet modulation — local control and for remote control from a building management system (MODBUS protocol).
4. DO NOT connect the communications cables (or shielded wires) between boilers until all boilers have had parameters set and then been started up following all instructions in the **KN** Boiler manual.

Figure 1 Termination DIP switches (located at lower left corner of control board) (component details are omitted for clarity)

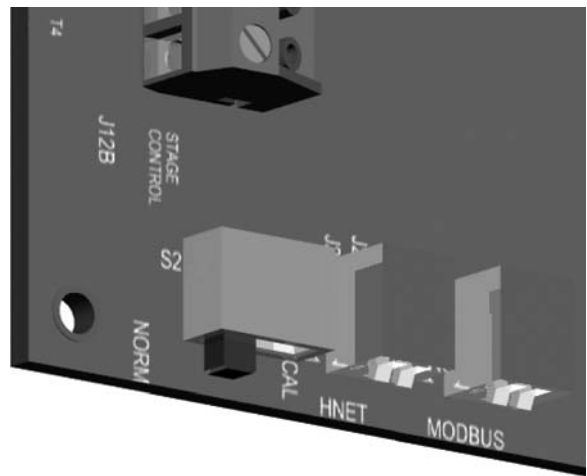

Table 2 Termination DIP switch settings (HeatNet switches are on left, MODBUS switches are on right)

Boiler	HeatNet	MODBUS (see note)
Master	Switch 1: ON Switch 2: ON	Switch 1: ON Switch 2: ON
Last member	Switch 1: ON Switch 2: ON	Switch 1: ON Switch 2: ON
Other members	Switch 1: OFF Switch 2: OFF	Switch 1: OFF Switch 2: OFF

Note: MODBUS setup is for applications controlled by a building management system. For systems using BACnet or LONWORKS, a bridge board is used to interface with the **KN** HeatNet control. If each boiler is directly controlled by the BMS, set the DIP switches for each boiler the same as for a master boiler (both switches on).

Control setup sequence

CAUTION **Follow the Boiler manual** — Install the boilers according to the **KN** Series Gas Boiler Installation & Operating Instructions manual before attempting to set up the control system.

1. Close the external gas valve on every boiler.
2. Wire all boilers following the guidelines in this manual.
3. Attach a header sensor (SYS/DHW HEADER terminals) to the master boiler ONLY. The **KN** HeatNet control automatically configures the boiler with a header sensor as the master.
4. Set the master boiler control parameters using its display/keypad.
5. Set the master boiler's termination DIP switches.
6. Set the termination DIP switches on the member boilers.
7. Set the member boilers' control parameters using their display/keypads.
8. Follow the instructions in the **KN** Series Gas Boiler Installation & Operating Instructions to start up each boiler before proceeding further.
9. Finish by connecting cables between the communications boards of all of the boilers and verifying network operation.

Wiring

1. See page page 16 for wiring information and wiring diagrams.
2. Note that the boilers can be wired for override operation. The wiring section provides information on override priorities.

2

Multiple boilers: HeatNet modulation *(cont.)*

WARNING Close the external manual gas valve on every boiler before proceeding. DO NOT open any gas valve, or attempt to fire any boiler, until the boilers have been set up and verified following the instructions in the **KN** Series Gas Boiler Installation & Operating Instructions.

Failure to comply could cause a boiler failure, leading to possible severe personal injury, death or substantial property damage.

Set control parameters

NOTICE Before turning boilers on to set parameters, disconnect all call for heat wiring at the electrical connection boards. This will prevent the boiler from attempting to cycle during the setup process.

1. See “Control menus and adjustments,” beginning on page 24 for a complete list of control parameters and explanations (Table 7, page 25 and Table 8, page 28).
2. Carefully read the parameter explanations in Table 9, page 30.
3. When adjusting the limit band, operating limit (OP LIMIT), local setpoint (LOC SETPOINT) and DHW setpoint, make sure the operating temperature bands do not overlap or cause potential for nuisance cycling.
4. System clock — Set the system clock on the master boiler ONLY, to ensure the time stamps will be accurate in the data logs.
5. Turn on the power to each boiler and set the on/off switch to ON as you set its parameters.
6. Use the boiler’s keypad to enter the parameters as described on page 24.
7. After setting a boiler’s parameters, turn off the power to the boiler until you are ready to start the boiler, following the Boiler manual instructions.
8. Set the master boiler and each member boiler, following the guidelines given in Table 3.

Start up boilers per KN I & OM

1. Turn off power to all boilers.
2. Follow all instructions in the **KN** Series Gas Boiler Installation & Operating Instructions to start up each boiler and verify operation.

Connect network cables

WARNING **Electrical shock hazard** — Turn off power to each boiler before attempting to connect the network cables.

NOTICE Before turning boilers on to check network operation, disconnect all call for heat wiring at the electrical connection boards. This will prevent the boiler from attempting to cycle during the setup process.

Master boiler cable

1. Connect an RJ45 cable to the master boiler H-Link OUT block (item 2, Figure 2, page 12) or 3-wire shielded cable to the H-Link terminal strip (item 4, Figure 2, page 12). The other end of this cable will be attached to the first member boiler in following steps.
2. Turn on power to the master boiler and set its on/off switch to ON.
3. You should hear at least 2 beeps.

2

Multiple boilers: HeatNet modulation *(cont.)***Table 3** Control parameters for HeatNet networks

Parameter	Requirement — MASTER boiler	Requirement — MEMBER boiler
SETPOINTS HEAT BAND	Set	Not applicable to MEMBER boiler unless boiler will operate in override mode
SETPOINTS LOCAL SETPT. SYSTEM SETPT. OPERATE LIMIT	Set if control will regulate boiler supply temp Set if control will regulate header or DHW tank temp (requires header sensor) Set	Set Set if needed for override operation Not needed Set
OP LIMIT BAND	Set	Set
SETPT SOURCE	Specify AUTO or 4-20mA remote control (AUTO uses the HeatNet control setup values for setpoint temperature; 4-20mA uses a 4-20mA signal to determine setpoint temperature as described in Table 9, page 30)	Set only if boiler will operate in override mode with 4-20mA input
OUTDOOR RESET, IF USED OA RESET	Enable if used	Not applicable to member boiler unless boiler is to operate in override mode
WARM WEATHER SD	Enable if used	
WWS SETPOINT	Set if used	
OA SETPTS	Set if used (requires outdoor sensor)	
SYSTEM PUMP POST PRG TIME	Applies ONLY if the control will cycle a system pump as well as the boiler pump Set or keep default	Not applicable to member boiler
ALWAYS ENABLE	Enable if desired	
SUMMER PUMP JOG	Enable if desired	
LOCAL PUMP DELTA TEMP ENABLE	Settings for boiler pump Enable if desired (requires installing a return water temp sensor)	Enable if desired (requires installing a return water temp sensor) Set value if enabled Set or keep default Enable if desired
DELTA TEMP	Set value if enabled	
POST PRG TIME	Set or keep default	
ALWAYS ENABLED	Enable if desired	
PUMP/VALVE OPTION	Enable constant pump if desired	Enable constant pump if desired
FLOW PROVE	Enable if used (connect flow switch)	Enable if used (connect flow switch)
NIGHT SETBACK	Set if desired	Not applicable to member boiler
OPTIONS (all)	Set	Set

2

Multiple boilers: HeatNet modulation *(cont.)***Table 3** Control parameters for HeatNet networks *(continued)*

Parameter	Requirement — MASTER boiler	Requirement — MEMBER boiler
AUX FUNCTIONS COMBUST AIR DAMPER	Select IN USE = YES to enable; select proof time or keep default (connect wires to damper and end switch); select COMMON or INDEPENDENT	Same as MASTER
ALARM SILENCE	Enable remote alarm silence if desired (connect terminals to remote switch)	Enable remote alarm silence if desired (connect terminals to remote switch)
FAILSAFE MODES	Enable LOW TEMP if desired for freeze protection; set temp as desired	Enable LOW TEMP if desired for freeze protection; set temp as desired
SYSTEM CLOCK	Set to ensure accuracy of time stamping	NO — set only on master boiler.
DISTRIBUTED CTRL H-NET ADDRESS	HeatNet address is automatic for MASTER = 255	Set from 2 to 16; unique address for each boiler
MODBUS ADDRESS	Set only if using BMS operation	Set only if using BMS operation
MODULAR BOILER SET ADD DELAY TIME	Adjust timings as needed to match control operation to system response	Not applicable to member boilers
SHED DELAY TIME		
MODULATE DELAY TIME		
MOD MAX-LAST FIRE		
FIRING MODE FIRING MODE	Select rotation method preferred	Not applicable to member boilers
MASTER FIRST	Enable if desired	
SENSORS	Select type or accept defaults; make sure installed sensors are listed and are the correct type; make sure HEADER sensor is connected to MASTER boiler only	ONLY return sensor would apply with member boiler, and ONLY if using DELTA TEMP or HEAT EXCHGER parameters
4-20mA INPUT	Set values for 4-20mA parameters if using either as primary control source or as an override	Set values for 4-20mA parameters if using as an override
PASSWORD	Set if desired	Set if desired
COMMUNICATIONS	Set if desired	Set if desired
LOAD DEFAULTS	Restore defaults if desired	Restore defaults if desired
SYSTEM	Load firmware if necessary to bring up to date	Load firmware if necessary to bring up to date

2

Multiple boilers: HeatNet modulation *(cont.)*

- The control's firmware version number will display. Make sure the firmware of all boilers is compatible. All boilers in a multiple boiler application should preferably have the same firmware version to ensure consistency. If versions are different, all versions must be either version 2.0 or greater, or version 1.x.
- After the control's timer finishes, the display will show **STANDBY** and **SYSTEM**. This verifies that the master boiler is setup correctly as the master. The same display will show on member boilers when there is a call for heat from the master boiler. When there is no call for heat at a member boiler, the display will show **LOCAL** instead.
- If the master is functioning correctly, the yellow LED's on the H-Link jack ports will blink. The blinking indicates that the master is trying to communicate with member boilers.
- If a **FAULT** message is displayed, clear the faults until the **STANDBY** message is displayed. Refer to troubleshooting suggestions in this manual if you cannot resolve the issue.

Member boiler cables

- Begin with the first member boiler.
- Plug the other end of the master boiler's communications cable to the member boiler's input port (Figure 2, page 12, item 2 for RJ45 cable or item 4 for 3-wire cable).
- Connect cables to all of the member boilers by cabling from one to the next. Connect incoming cables to item 1 or 4, Figure 2, page 12. Connect outgoing cables to item 2 or 4. (Note that shielded cable wires will share terminals when using item 4.)

Check the network

- Turn the power on and the on/off switch to **ON** for all of the member boilers.
- Allow time for each boiler to initialize.
- After about 30 seconds, the master boiler should recognize the member boilers.
- Navigate to the **BOILERS** menu, then to **HEAT NET BOILERS** display. The master control will show the boilers it recognizes.
- If the display shows a blank space, such as "123_56789," the control does not detect the missing boiler (boiler 4). Check the yellow LED on the communication port of the missing boiler.
- NORMAL** connection — LED should flash steadily, about twice per second.
- TERMINATION** incorrect — LED will flash rapidly and stay on.
- OPEN** connection — LED does not flash at all.
- If a **FAULT** message is displayed, clear the faults until the **STANDBY** message is displayed. Refer to troubleshooting suggestions at the end of this manual if you cannot resolve the issue.

Start the system

- Turn off power to all boilers.
- Connect all call for heat wiring to the boilers.
- Turn on power to all boilers and turn the on/off switches to **ON**.
- The boilers should now operate normally, as described in the Boiler manual.
- The master boiler will sequence and modulate boilers as necessary to control the water temperature.
- The master boiler will show the number of boilers firing as well as the temperature and heat band display. Use the **UP/DOWN** keys to scroll through the displays to watch the process of starting and stopping boilers.

Figure 2 RS485 communications connectors

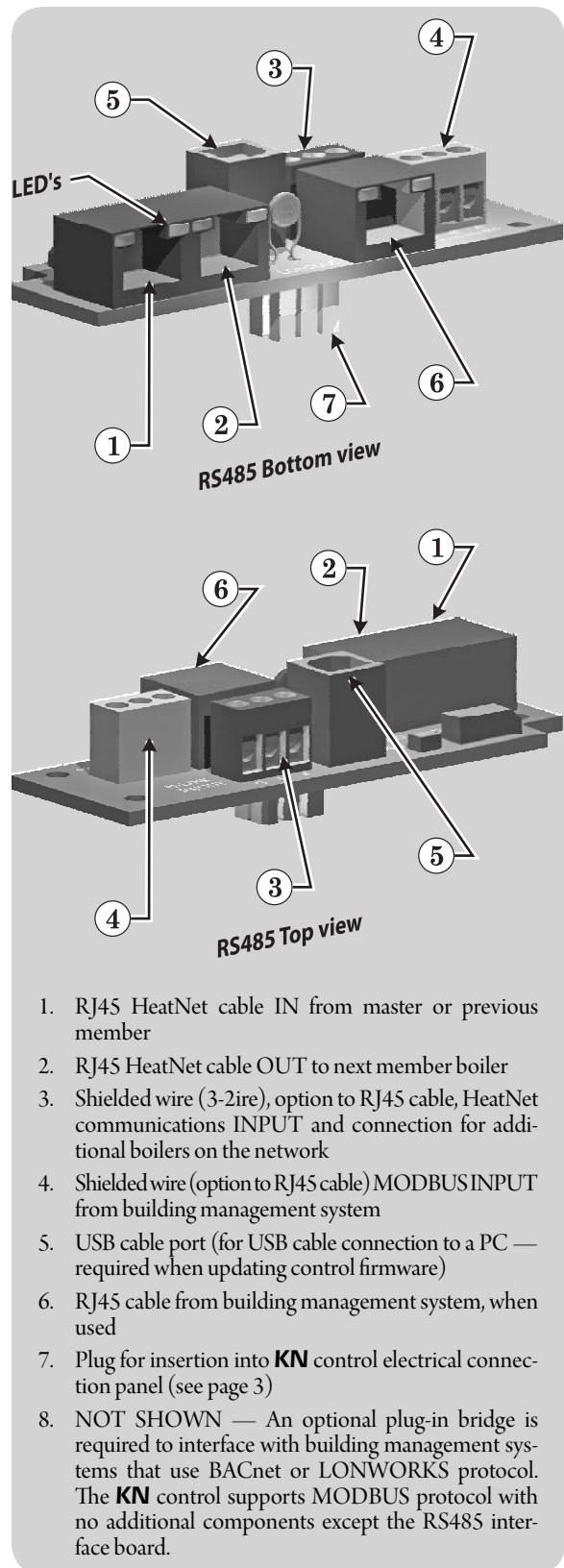

3

Multiple boilers: BMS operation

Option 1: Combined BMS/HeatNet

1. This method uses an RS485 digital communications cable with the MODBUS protocol to control a boiler or HeatNet network.
2. The boiler or boiler network will operate as in the HeatNet local control method (Section 1 of this manual). But, instead of the HEAT DEMAND input, a software form of the HEAT DEMAND input is used (address 40001 — Boiler/System Enable/Disable).
3. The System Setpoint Timer needs to be loaded periodically to allow the HeatNet system to revert to local control from the master boiler in the event communications is lost.
4. The MODBUS protocol allows writing and reading registers using MODBUS commands. An optional BACnet or LonWorks bridge module can be used to connect the MODBUS network to a BACnet or LonWorks network.
5. This method allows enabling and disabling the boiler or HeatNet system; changing setpoints; and reading boiler status or temperatures remotely, using digital commands from a Building Management System.
6. The master boiler assumes the role of MEMBER, RTU, 19.2Kb, 8 bits, Even Parity, 1 stop bit, when connected to a BMS.
7. The Member Boilers should not be connected to a BMS system other than to view read-only addresses.

Option 2: Total MBS control

1. This option uses direct control of each boiler (and requires a BACnet or LonWorks bridge on each boiler if not using MODBUS). The MBS controls each boiler directly, except when the boiler is wired and activated for override operation.
2. Consult the website for address configuration information, at info.www.hydrothermkn.com. Click the “HeatNet On Board” icon.

MODBUS registers

1. See Table 4, page 13; Table 5, page 13; and Table 6, page 14 for register requirements.
2. The system setpoint timer and system setpoint work in tandem to externally control the operating setpoint.
3. The setpoint (countdown) timer should be loaded with a timeout value (in seconds) prior to writing the system setpoint.
4. When the timer reaches zero, the control assumes that the BMS is no longer operating and the local setpoint (saved on the master control) is reloaded.
5. This is a fail-safe feature used to help safeguard the system in case of BMS failure.
6. If the setpoint timer is not written, a default timeout value of 60 seconds is assumed.
7. To write the system clock, registers 40009 – 40015 must first be loaded with the correct date and time. Then, a 1 must be written to register 16 to write the date and time to the system clock.

Table 4 MODBUS holding (read/write) registers

Address	Data Type	Description	Valid Values/Range
40001	Unsigned	Boiler/System Enable/Disable	0 = Disabled/Off 1 = Enabled/On
40002	Unsigned	System Setpoint Timer (1)	0 – 65535 seconds
40003	Unsigned	System Setpoint (1)	40°F – 220 °F
40004	Unsigned	Outdoor Air Reset Enable/Disable	0 = Disabled/Off 1 = Enabled/On
40005	Unsigned	Outdoor Air Setpoint	40°F -100 °F
40006	Unsigned	Water Temperature at High Outside Air	60°F -150 °F
40007	Unsigned	High Outside Air Temperature	50°F -90 °F
40008	Unsigned	Water Temperature at Low Outside Air	70°F -220 °F
40009	Signed	Low Outside Air Temperature	-35°F -40 °F
40010	Unsigned	Set Clock – Month (2)	0 – 11
40011	Unsigned	Set Clock – Day of Month (2)	1 – 31
40012	Unsigned	Set Clock – Year (2)	0 – 99
40013	Unsigned	Set Clock – Hours (2)	0 – 23
40014	Unsigned	Set Clock – Minutes (2)	0 – 59
40015	Unsigned	Set Clock – Seconds (2)	0 – 59
40016	Unsigned	Set Clock – Day of Week (2)	1 – Monday 7– Sunday
40017	Unsigned	Set Clock – After the Set Clock Registers listed above have been written, a 1 must be written to this location to set the clock. (2)	1
Note (1)	The system setpoint timer and system setpoint work in tandem to externally control (i.e. a BMS - building management system) the operating setpoint. The System Setpoint (countdown) timer should be loaded with a timeout value (in seconds) prior to writing the system setpoint. When the timer reaches zero, the control assumes that the BMS is no longer operating and the local setpoint (saved on the control) is reloaded. This is a failsafe feature used to help safeguard the system in case of BMS failure. If the setpoint timer is not written, a default timeout value of 60 seconds is assumed.		
Note (2)	To write the system clock, registers 40009 – 40015 must first be loaded with the correct date and time. Then, a 1 must be written to register 16 to write the date and time to the system clock.		

Table 5 Boiler status flags

Bit	Description	Bit	Description
0	Disabled	16	Pilot Valve
1	Local Override	17	Blower
2	Alarm	18	Ignition Alarm
3	Failed	19	Valve Alarm
4	Member Error	20	High Limit
5	Boiler Running	21	Air Prove Switch
6	Pump Running	22	XS Factory
7	Spare 3 Interlock	23	Software Operator
8	LWCO Interlock	24	Header (SYS/DHW) Sensor not Present
9	VFD Interlock	25	Supply Sensor not Present
10	Gas Prove	26	Return Sensor not Present
11	Spare 4	27	Outside Air Sensor not Present
12	Operator Interlock	28	— —
13	Water Prove (Flow) Interlock	29	— —
14	Air Prove UV Sensor Interlock	30	Master Boiler
15	Main Valve	31	Present (Boiler Detected)

3

Multiple boilers: BMS operation *(cont.)*

BACnet or LONWORKS protocols

1. Install the correct bridge to adapt to building management systems using BACnet or LONWORKS protocols. Each boiler must have a bridge if the BMS is to operate with direct control of each boiler (option 2, page 13).
2. The bridge translates the BACnet or LONWORKS input to the MODBUS protocol for compatibility with the HeatNet controls.

Wiring and set-up

1. Wire and set up the master boiler and member boilers exactly as for HeatNet modulation — local control applications. See section beginning on page 8.
2. ALL control parameters must be set up just as for the local control method.
3. The ONLY difference in setup is the termination DIP switch settings. Use the settings for MODBUS communications given in Table 2, page 8.
4. Connect communications cables (RJ45 or shield-wire cables) between the control communications boards as for the local control method.
5. Verify network operation BEFORE connecting the building management system.

Connect the BMS cable

1. DO NOT connect the building management system cable until the boiler network has been proven to operate independently. The system is designed to revert to local control by the master boiler should communications with the building management system be lost.
2. Turn off power to the master boiler.
3. See Figure 2, page 12. Connect an RJ45 cable to the BMS input port, item 6. Or use shielded wire cable, connected to terminal block, item 3.

Verify BMS/HeatNet operation

1. Turn on power to the master boiler.
2. Allow the master boiler to initialize.
3. Verify operation with the building management system.

Table 6 MODBUS input (read-only) registers

Address	Data Type	Description	Valid Values/Range
30001	Unsigned	Boilers Running	0 – 16
30002	Unsigned	Modulation (% BTU Load)	0 – 100
30003	Signed	Header / System Temperature	32 – 250 °F
30004	Signed	Supply Temperature	32 – 250 °F
30005	Signed	Return Temperature	32 – 250 °F
30006	Signed	Outside Air Temperature	-40 – 250 °F
30007	Signed	Spare Input 1	-32768 to 32767
30008	Signed	Spare Input 2	-32768 to 32767
30009	Unsigned	Clock – Month	0 – 11
30010	Unsigned	Clock – Day	1 – 31
30011	Unsigned	Clock – Year	0 – 99
30012	Unsigned	Clock – Hours	0 – 23
30013	Unsigned	Clock – Minutes	0 – 59
30014	Unsigned	Clock – Seconds	0 – 59
30015	Unsigned	Clock – Day of Week	1 – Monday 7 – Sunday
30016 – 30047	Unsigned	Boilers 1 – 16 status flag (32-bit) registers. The upper 16-bits of each 32-bit register is stored at odd numbered addresses 30016 – 30046. The lower 16-bits of each 32-bit register is stored at even numbered addresses 30017 – 30047.	See the Boiler Status Flags Table Below
30048 – 30079	Unsigned	Boilers 1 – 16 runtime (32-bit) registers. The upper 16-bits of each 32-bit register is stored at odd numbered addresses 30048 – 30078. The lower 16-bits of each 32-bit register is stored at even numbered addresses 30049 – 30079. When the upper and lower registers are combined they form a 32-bit unsigned integer that is the number of seconds that the boiler has been running. For instance: (((Register 29) * 65536) + Register 30) = Boiler 1 runtime in seconds. Boiler 1 is the master boiler. Boilers 2 – 16 are member boilers.	0 – 4294967295 seconds

4

External 4-20ma control

WARNING **Electrical shock hazard** — Disconnect all electrical power sources to the boiler before making any electrical connections.

Label all wires prior to disconnection when servicing controls. Wiring errors can cause improper and dangerous operation! Verify proper operation after servicing.

Failure to comply with the above could result in severe personal injury, death or substantial property damage.

NOTICE The electrical connections to this boiler must be made in accordance with all applicable local codes and the latest revision of the National Electrical Code, ANSI /NFPA-70. Installation should also conform to CSA C22.1 Canadian Electrical Code Part I if installed in Canada. Install a separate 120 volt 15 amp circuit for the boiler for KN-6 and KN-10 (208/230/240 VAC/1/60, 20-amp for KN-20). A properly rated shut-off switch should be located at the boiler. The boiler must be grounded in accordance with the authority having jurisdiction, or if none, the latest revision of the National Electrical Code, ANSI/NFPA-70.

Line voltage field wiring of any controls or other devices must use copper conductors with a minimum size of #14 awg. Use appropriate wiring materials for units installed outdoors.

CAUTION **Follow the Boiler manual** — Install the boilers according to the **KN** Series Gas Boiler Installation & Operating Instructions manual before attempting to set up the control system.

NOTICE If using a 0-10 VDC signal multiply any references to current in the manual by 0.5. Example: 5ma / 0.5 = 2.5 VDC.

Option 1: Modulation using HeatNet control

1. Set up the boilers following the instructions for a HeatNet modulated system, beginning on page 8.
2. See Figure 7, page 21 for wiring from the 4-20mA external controller. The controller must provide the 4-20mA signal and a contact for each boiler to enable its operation by closing across the Remote Enable contact.
3. Set parameters as for the HeatNet modulated system.
4. Closing the 4-20mA enable contact will cause the master boiler to modulate all boilers at a level proportional to the 4-20mA signal.
5. Make sure to set the 4-20mA parameters for compatible boiler start current.

Option 2: Direct modulation, up to 5 boilers

1. Set up parameters as for a stand-alone boiler, beginning on page 6.
2. The 4-20mA input is daisy-chained (connected in series) from boiler to boiler. Connect the 4-20mA input signal with its “+” input on boiler 1, and its “-” input on the last boiler. Then connect the 4-20mA input terminals from boiler to boiler in series; i.e., the - from boiler 1 goes to + on boiler 2, etc.
3. Close the external gas valve on every boiler.
4. Wire all boilers following the guidelines in this manual.
5. DO NOT install a header (SYS/DHW HEADER) sensor on any of the boilers.
6. Disconnect the wires to the boilers’ Remote Enable terminals (and any override wiring to Heat Demand or DHW Demand terminals) to ensure there will be no call for heat while proceeding.
7. Set the boilers’ control parameters using their display/keypads.
8. Follow the instructions in the Boiler manual to start up each boiler before proceeding further.
9. Finish by reconnecting call-for-heat wiring, then operating the complete system to verify operation in all modes.

Option 3: Remote setpoint operation

1. A HeatNet system or an individual boiler can be operated using remote setpoint by providing a 4-20mA input and enable. Set the 4-20mA parameters for compatible boiler start current and correct temperature range.
2. See Figure 7, page 21 for wiring from the 4-20mA controller.

Wiring

1. See page 16 for wiring information and wiring diagrams.
2. Note that the boilers can be wired for override operation. The wiring section provides information on override priorities.

5

Wiring

Power supply (120 VAC)

1. Connect minimum 14awg copper wire to the power connection. See Figure 4, page 18.
2. Install a fused service switch, mounted and installed in accordance with all applicable codes.

Circulator wiring

CAUTION All circulators operated by the HeatNet control require a motor starter or relay to handle the power load of the circulator. Use the output terminals of the **KN** HeatNet control **ONLY** to operate the starter or relay coil.

Boiler circulator

- If the boiler circulator is to be controlled by the boiler's HeatNet control, power the boiler circulator starter or relay coil through the terminals provided on J13 (see Figure 4, page 18).

System circulator

- If the system circulator is operated by one of the HeatNet controls (by the MASTER boiler control for HeatNet multiple boiler systems), power the boiler circulator starter or relay coil through the terminals provided on J13 (see Figure 4, page 18).

Sensor wiring

- **Factory-installed sensors** — **KN** boilers are provided with a factory-installed supply sensor (boiler outlet water temperature), connected to the terminals on J10.
- **Header (SYS/DHW HEADER) sensor is required** — A header sensor (SYS/DHW HEADER) must be installed in the system supply piping (or DHW tank) for HeatNet controlled systems.
 - **Connect the header sensor ONLY to the master boiler.**
 - Install the header sensor in an immersion well.
 - Locate the sensor where it will accurately sense the system water supply temperature.

- Connect the sensor leads to the MASTER boiler electrical connection board terminals on J10 as shown in Figure 5, page 19.

- The header sensor can be used with a stand-alone boiler to allow regulation of a primary/secondary system, or to control DHW tank temperature.

- **Outdoor reset application** — To operate with outdoor reset, purchase and install an optional outdoor sensor.

- Mount the sensor such that it is shielded from direct sunlight if possible and not likely to be covered by snow drifts or debris.

- Connect the outdoor sensor leads to the electrical connection board terminals on J10 as shown in Figure 5, page 19.

- The sensor must be connected to the MASTER boiler for a HeatNet system.

- A member boiler could have its own outdoor sensor if it is to be activated in override mode by closing the Heat Demand terminals.

- The outdoor sensor can also be connected to a stand-alone boiler connection board.

- **Return water temperature sensor** — The return water temperature sensor is optional, but is needed for some of the parameter options.

- Parameters that require the return water temperature sensor are DELTA TEMP (under PUMP OPTIONS) and EXCHGR DELTA (under AUX FUNCTIONS).

- Install the sensor in a well in the boiler return piping. Connect the sensor leads to the electrical connection board terminals on J10 as shown in Figure 5, page 19.

- Each boiler requires a return water temperature sensor in order to use the DELTA functions.

5

Wiring *(continued)*

DHW wiring

- To operate the boiler for domestic water heating with a storage tank, install and pipe the tank according to the tank manufacturer's instructions and the recommended piping diagrams in the **KN** Series Gas Boiler Installation & Operating Instructions manual. Consult the factory for applications not covered.
- If using the SYS/DHW HEADER sensor in the DHW tank, the DHW circulator should be activated using the SYSTEM CIRCULATOR terminals on the electrical connection board.

External interlocks

- If used, wire external limits and flow switch, as shown in Figure 6, page 20.
- If wiring to and from a motorized combustion air damper (or dampers), follow the guidelines given in Figure 6, page 20. Connect only to the master boiler. Make sure the AUX FUNCTION options are set correctly.

CAUTION

If any of the member boilers is to operate in override mode, and the system is equipped with a single, master combustion air damper, you must provide special wiring in order to ensure the damper opens and proves when the boiler fires. This must be done without compromising the wiring between the master boiler and the damper.

Overrides — Control priorities

- The **KN** HeatNet control can provide override operation for any or all boilers in a HeatNet network. This requires the boilers be piped with appropriate isolation piping and controls as needed for isolation.

CAUTION

Do not wire boilers for override operation unless the piping design provides automatic isolation of the overriding boilers. The master boiler would be unable to properly control system water temperature if member boilers were to input heat to the system without control from the master. DHW operation, in particular, would raise the supply temperature from overriding boilers to the DHW Setpoint.

NOTICE

Override operation control setup — MEMBER boilers must be set up with operating parameters necessary during their override (local) operation.

- A **KN** HeatNet boiler will respond to overrides in the following order. The modes listed will override any other activation function listed below it.

Figure 3 Boiler input priorities

MASTER BOILER	MEMBER BOILER
<p>Priority 1 AA terminals ON/OFF operation</p> <p><i>Master boiler operates in ON/OFF and fires all member boilers ON/OFF together based on system settings. See Figure 8, page 22 for wiring connections.</i></p>	<p>Priority 1 AA terminals ON/OFF operation</p> <p><i>Member boiler switches to local control in ON/OFF operation, using the boiler's settings. See Figure 8, page 22 for wiring connections.</i></p>
<p>Priority 2 HEAT DEMAND</p> <p><i>Master boiler operates in full modulation and fires/modulates member boilers based on system settings.</i></p>	<p>Priority 2 HEAT DEMAND</p> <p><i>Member boiler switches to local control, using the boiler's settings for operation and modulation.</i></p>
	<p>Priority 3 HeatNet input</p> <p><i>Member boiler receives operating commands from the master boiler through the cable or shielded wires between HeatNet boilers.</i></p>
<p>Priority 3 4-20mA/0-10VDC input</p> <p><i>Requires closure across the 4-20mA ENABLE terminals. Master boiler operates and controls member boilers based on 4-20mA signal received at master.</i></p>	<p>Priority 4 4-20mA/0-10VDC input</p> <p><i>Requires closure across the 4-20mA ENABLE terminals. Member boiler operates on local control based on 4-20mA signal received at member.</i></p>
<p>NOTICE Setting the 4-20mA parameter to HIGHEST in the ADVANCED SETUP menu will cause 4-20mA ENABLE to move to priority 1.</p>	
<p>Priority 4 T1/T2 stage control</p> <p><i>Master boiler operates based on closure of T1 and T2 terminals on master, firing member boilers at the same rate. See Figure 8, page 22 for wiring connections.</i></p>	<p>Priority 4 T1/T2 stage control</p> <p><i>Member boiler operates on local control based on closure of T1 and T2 on member boiler. See Figure 8, page 22 for wiring connections.</i></p>

5

Wiring (continued)

Figure 4 KN HeatNet control field wiring (also see **KN Gas Boiler Installation & Operation Instructions**) — Verify against wiring diagram supplied with boiler

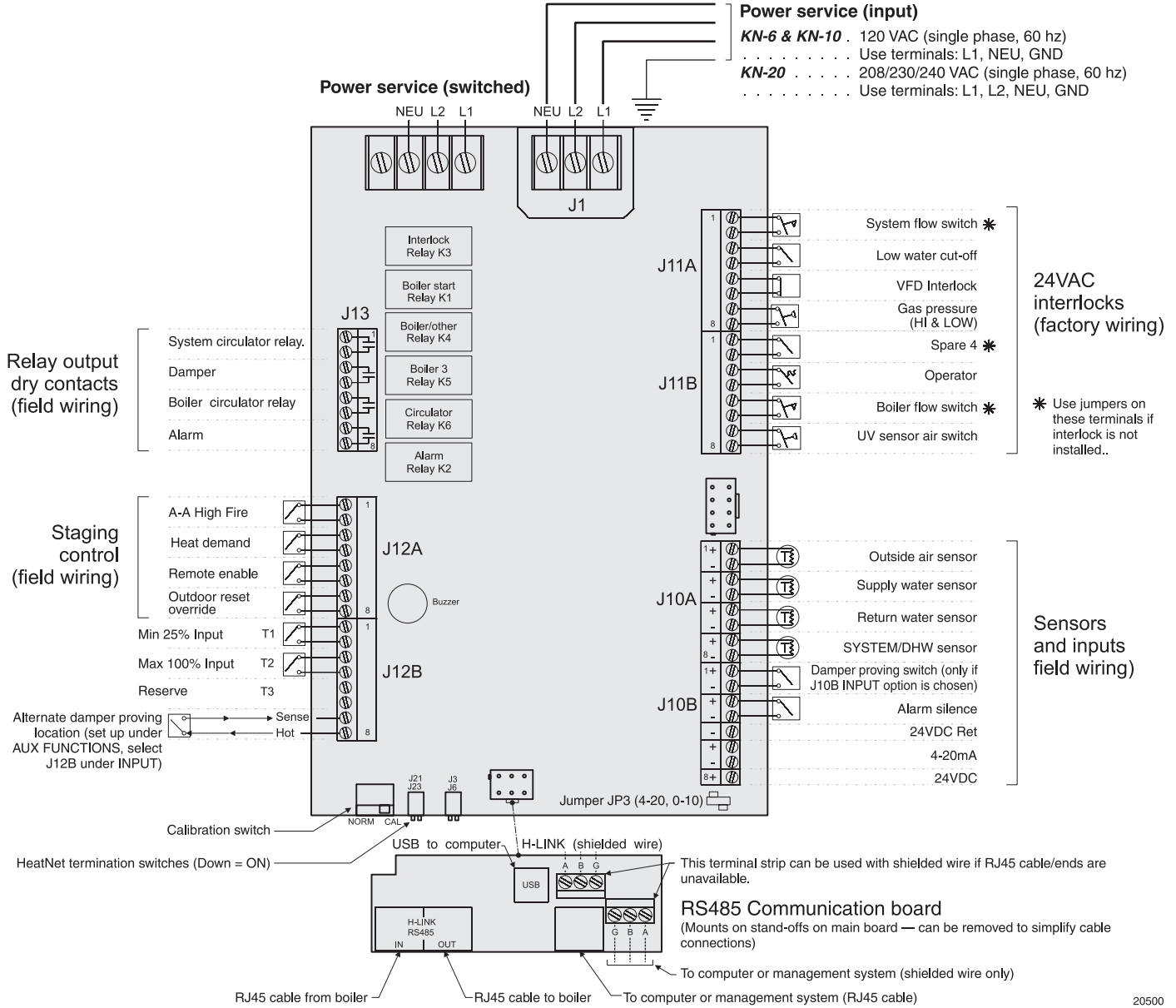

20500

5

Wiring (continued)

Figure 5 KN HeatNet temperature sensors

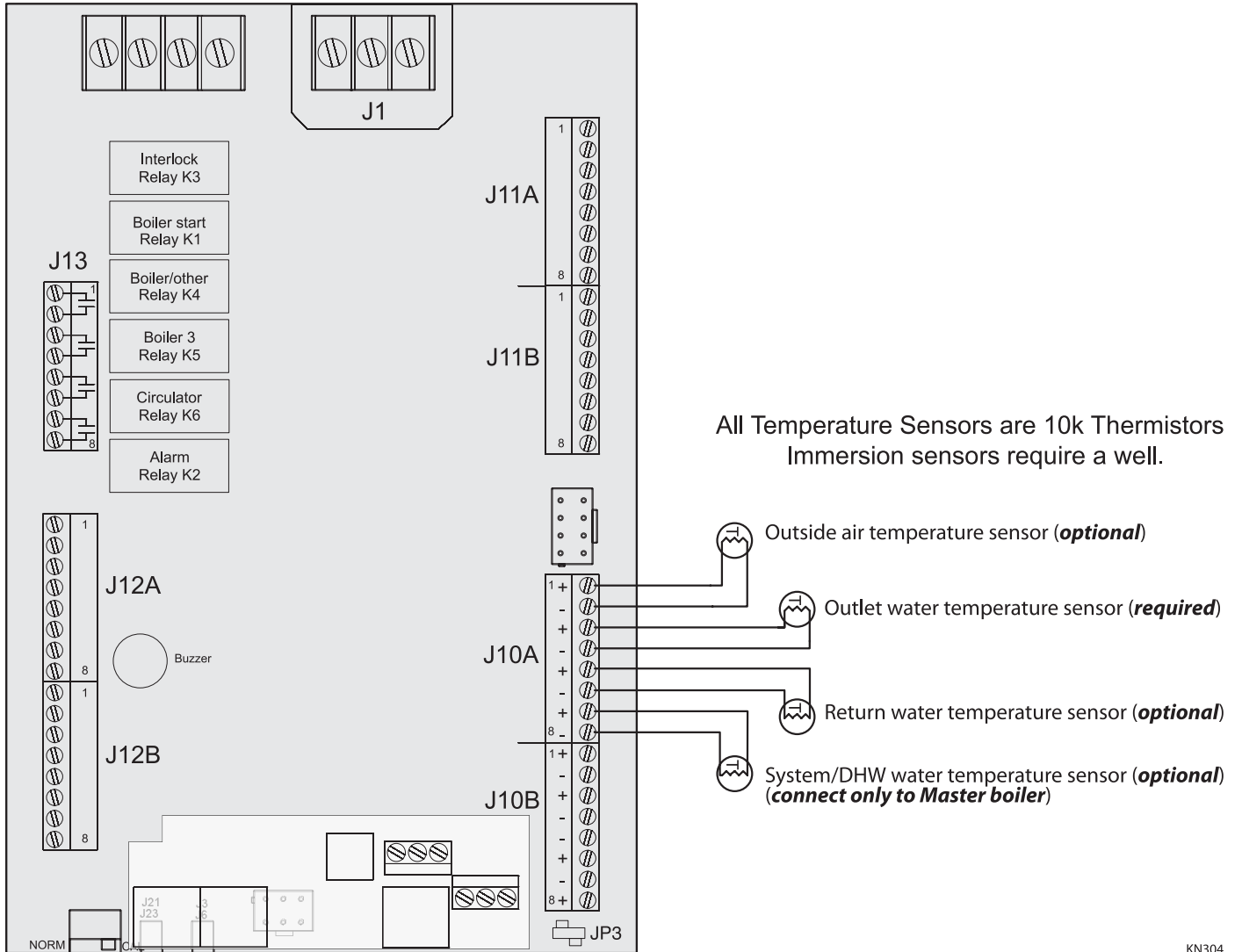

All Temperature Sensors are 10k Thermistors
Immersion sensors require a well.

KN304

5

Wiring (continued)

Figure 6 Field wiring — relays, interlocks and boiler status

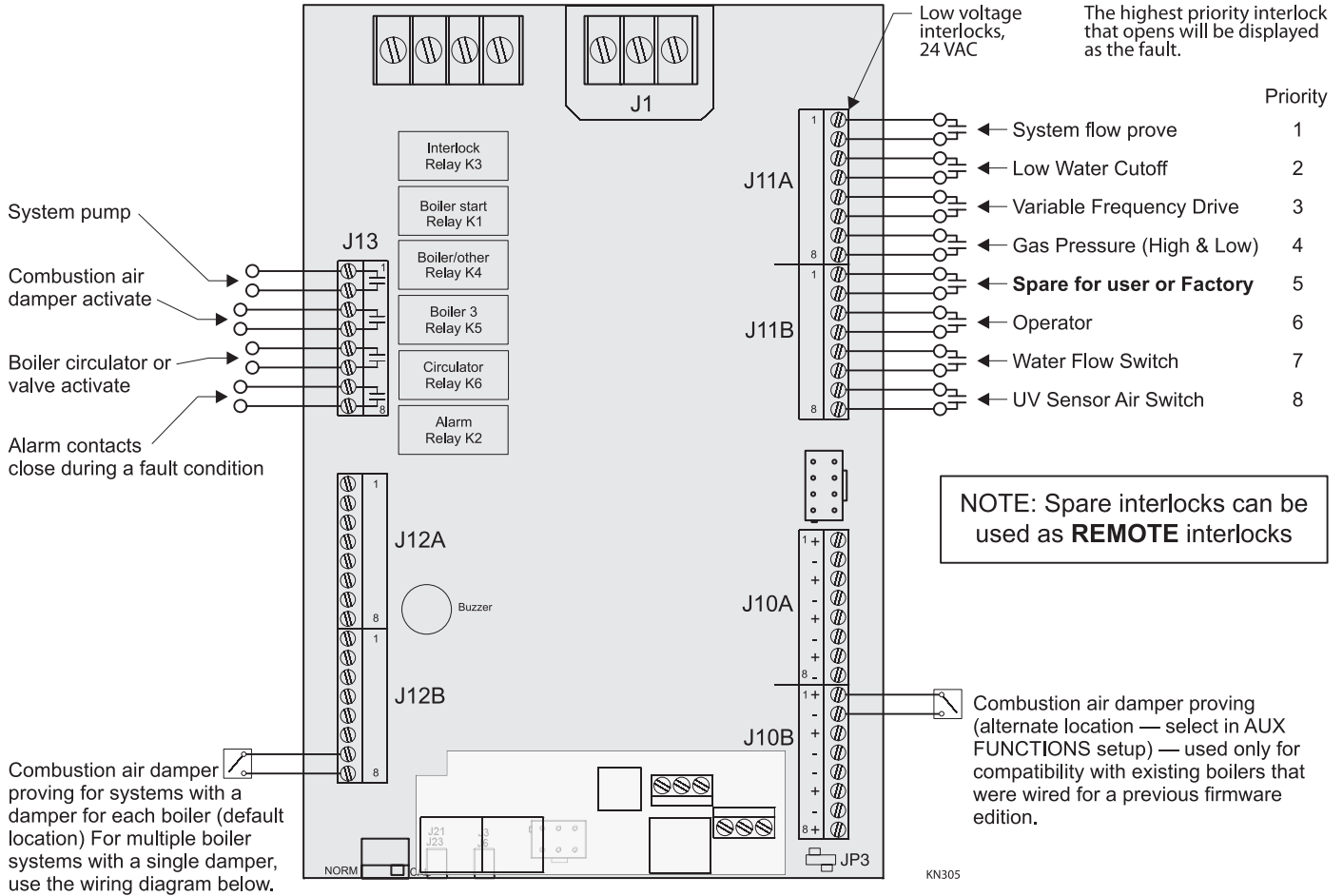

NOTE: Apply the following wiring when connecting **multiple boilers with a single combustion air damper**. Member boilers set up for Failsafe mode (boiler starts if signal from master boiler is lost) must be able to activate the combustion air damper when operating. The following wiring will allow that. All member boilers set up for Failsafe operation must be wired as shown.

NOTE: *You must install a separate 24 VAC transformer* to power the combustion air damper in order for this wiring to work correctly.

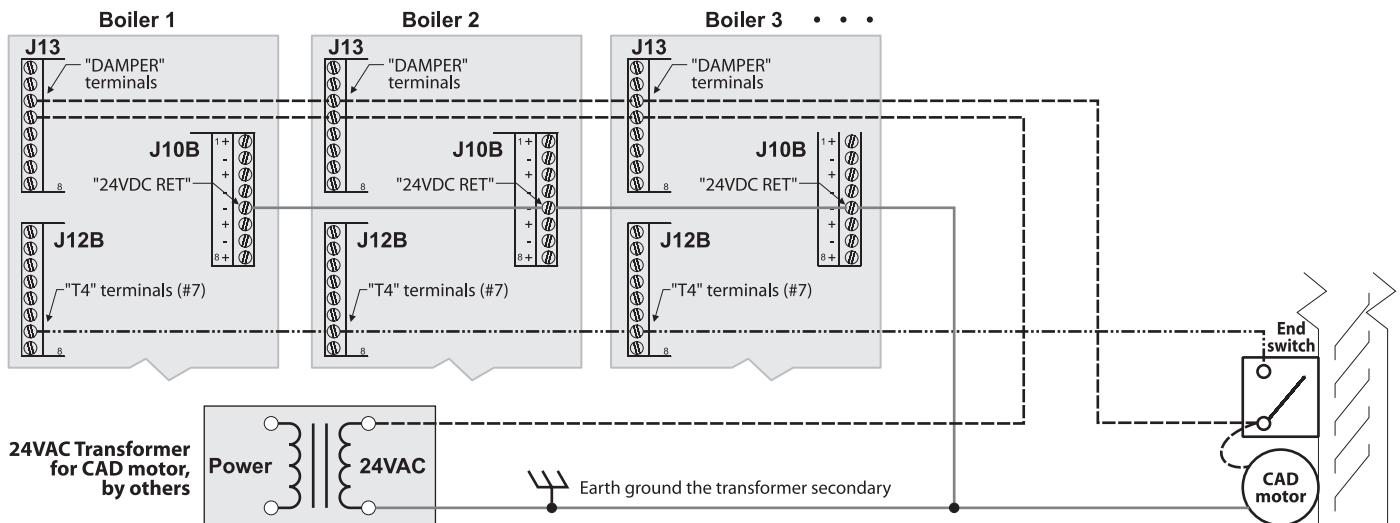

5

Wiring (continued)

Figure 7 Field wiring connections for 4-20mA remote operation

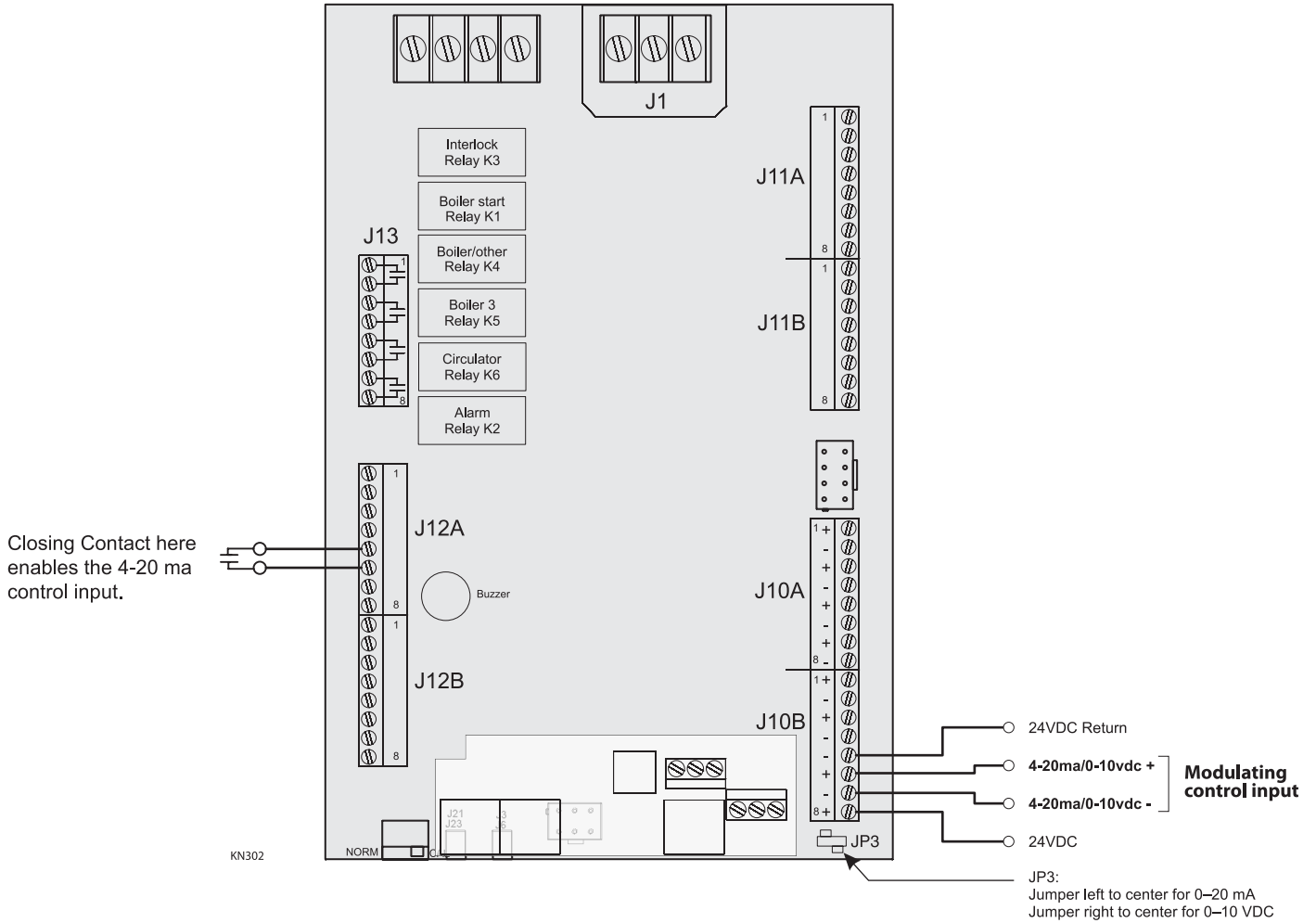

5

Wiring (continued)

Figure 8 Field wiring connections for on/off and two-stage firing options

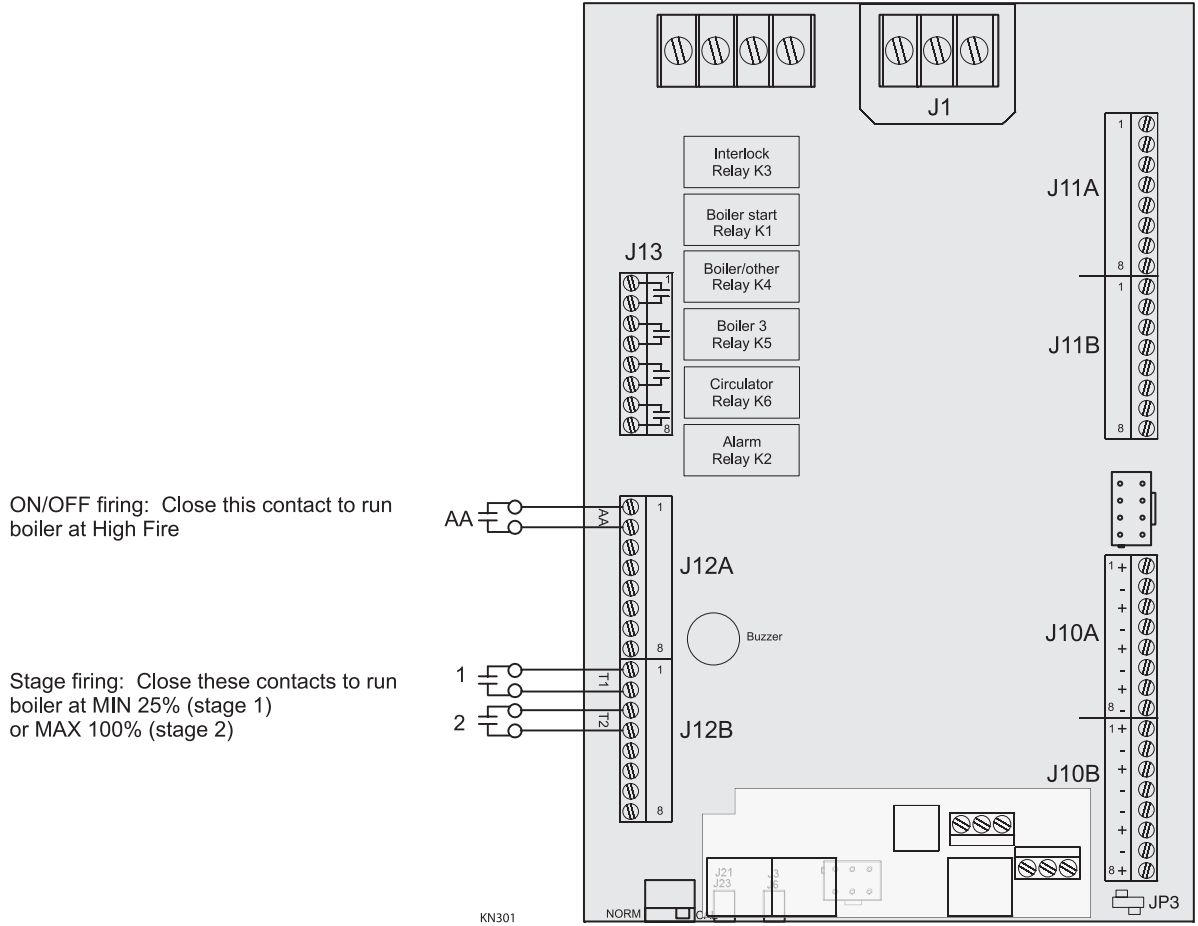

5

Wiring (continued)

Figure 9 Installation of optional BACnet or LonWorks bridge — processor (for MODBUS operation)

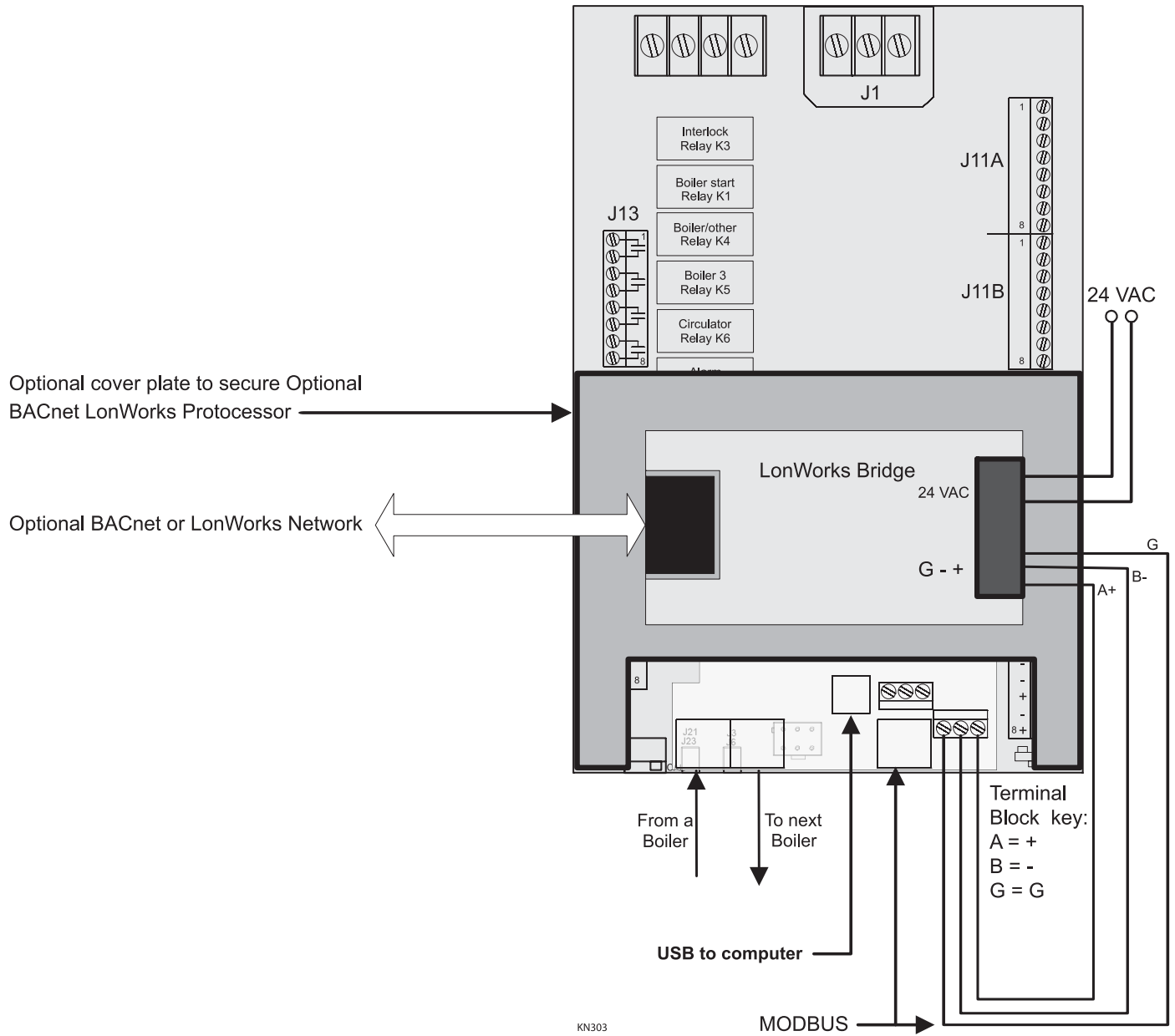

6

Control menus and adjustments

The Heat Net control display

Starting the display

1. Check all wiring to make sure it is complete and all wires are securely connected.
2. Verify that the HEAT DEMAND and DHW DEMAND wires are removed.
3. Close the external gas valve on every boiler.
4. Turn on power to the boiler and then turn the boiler on/off switch ON.
5. The control will beep at least twice and the display will show the first STANDBY display in Figure 10. Note that pushing the DOWN button on the keypad will change the right side of the display as shown, providing information on various setpoints and parameters.
6. The display, LOCAL SET, means the setpoint temperature for a single boiler application. Figure 10 shows the factory default values.

Adjusting setpoint temperature while in Standby

1. The local setpoint temperature (LOCAL SET) or system setpoint temperature (SYS/DHW HEADER) can be adjusted using the SETUP menu or by pressing down the SELECT key for one second while in Standby.
2. The setpoint will begin to flash. Use the arrow keys to increase or decrease the setpoint.
3. When satisfied, press SELECT to keep the new number. To cancel and return to Standby, press the BACK button.

Accessing setup menus

1. With the display in STANDBY, press and hold the BACK key for 5 seconds.
2. The display will change to:

```

▶ SETUP
  ADVANCED SETUP
  VIEW LOG
  
```

3. Press the SELECT key to select setup. (Note that pressing the DOWN key would change the selection to ADVANCED SETUP or VIEW LOG.)
4. The display will now show the first options in the setup menus:

```

▶ KN SERIES V 2.1
  BOILERS
  SETPOINTS
  OUTDOOR AIR RESET
  
```

NOTICE All boilers on a network must have firmware revisions of 2.0 or above, or all can have revision 1.x. Do not mix 2.x firmware boilers with 1.x firmware boilers. Follow the procedure in this manual (Table 9, page 30) to install a firmware update on each boiler as necessary. To ensure consistent setup, all boilers should preferably have the SAME firmware edition.

5. Press the DOWN key to access additional menu options. Pressing the DOWN button once will change the display to:

```

▶ KN SERIES V 2.1
  BOILERS
  SETPOINTS
  OUTDOOR AIR RESET
  
```

6. The cursor moves to the second line, indicating this option could now be selected with the SELECT key.
7. Continuing to press the DOWN key will access the menu options listed on the following pages. Table 7, page 25 lists the sequence of menu items found under the SETUP menu. Table 8, page 28 lists the sequence of menu items found under the ADVANCED SETUP menu. For an explanation of the parameters, see Table 9, page 30.

Figure 10 Heat Net display during Standby (no call for heat) — pressing the DOWN key on the keypad changes the display as shown. LOCAL SET or SYS/DHW HEADER can be adjusted while in Standby as described in this section.

```

STANDBY LOCAL SET
180°F
  
```

NOTICE The above display occurs on single-boiler installations only (no header sensor installed).

— OR —

```

STANDBY SYS/DHW
180°F
  
```

NOTICE The above display occurs when boilers are connected to a HeatNet network.

```

STANDBY *STATUS
          START 0
          STOP  0
  
```

```

STANDBY RETURN
180°F
  
```

```

STANDBY OUTSIDE
180°F
  
```

```

STANDBY SUPPLY
180°F
  
```

```

STANDBY HEADER
NA
  
```

NOTICE The “NA” appears if a sensor is not connected to the SYS/DHW HEADER sensor terminals. The master boiler (where the SYS/DHW HEADER sensor is attached) will show the SYS/DHW HEADER temperature in lieu of NA.

```

STANDBY LOCAL SET
180°F
  
```

6

Control menus and adjustments *(continued)*

Table 7 SETUP menus (see Table 9, page 30 for explanations)

To enter Setup: From STANDBY, hold **BACK** for 5 seconds. (If SKIP PASSWORD is set to OFF, you will have to enter the password.)

Then press **SELECT** with cursor on **SETUP**.

Make sure there is no call for heat at the boiler before attempting to perform setup adjustments.

To return to STANDBY, press/release **BACK** until the display returns to standby, or turn boiler ON/OFF switch off, then on.

Level 1	Level 2	Level 3	Default {Range}	Typical line	
next item to select	next item to select back one level	next item to select back one level	to change value to accept value and return to previous menu level	(Display shows four lines at a time; cursor indicates active line)	
KN V.X.X			Shows firmware version number	KN SERIES V 2.45	
BOILERS	# OF BOILERS		1 {1 to 16} — display only — gives the number of boilers on a HeatNet network	# OF BOILERS 1 LEAD BOILER # 1 HEAT BAND 30°F HNT 123456789 ^{0'1'1'2'3'4'5'6}	
	LEAD BOILER #		Always shows "1" — display only, not adjustable		
	HEAT BAND		30°F {10 to 50°F}		
	HEAT NET BOILERS 123...		Display only, on MASTER boiler only — shows the H-NET ADDRESS of each boiler detected on the HeatNet network (from 1 to 16) NOTE that the MASTER address, actually 255, is shown as 1 in this display		
SETPOINTS	LOCAL SETPT or SYSTEM SETPT		180°F {40 to 180°F} SYSTEM SETPT will appear if a sensor is connected to the SYS/DHW HEADER terminals. Otherwise, the display will show LOCAL SETPT.	LOCAL SETPT 180°F OPERATE LIM 10°F OP LIM BAND 215°F SETPT SOURCE AUTO	
	OPERATE LIMIT		205°F {145 to 205°F}		
	OP LIM BAND		10°F {1 to 50°F}		
	SETPT SOURCE		AUTO {AUTO, 4-20MA} (NOTE: If 4-20MA is selected, the control setup menu will automatically open the ADVANCED SETUP 4-20MA INPUT menu to allow setting the operating levels to match the 4-20MA remote signal controller requirements.)		
OUTDOOR AIR	OA RESET		OFF {ON or OFF}	OA RESET OFF WARMWEATHER SD NO OA SETPOINT 68°F SET OA SETPOINTS	
	WARM WEATHER SD		NO {YES or NO}		
	WWS SETPOINT		68°F {40 to 100°F} If the OA OVR input is closed, outdoor reset and warm weather shutdown are overridden. The boiler will run at LOCAL/SYSTEM SETPOINT.		
	SET OA SETPOINTS	WATER TEMP AT HIGH OA TEMP		140°F {60 to 150°F} 70°F {50 to 90°F}	WATER TEMP 40°F AT HIGH OA TEMP 70°F NEXT
		WATER TEMP AT LOW OA TEMP		180°F {70 to 180°F} 10°F {-35 to +40°F}	















6

Control menus and adjustments *(continued)***Table 7** **SETUP** menus *(continued)* (see Table 9, page 30 for explanations)

Level 1 next item to select	Level 2 next item to select back one level	Level 3 next item to select back one level	Default {Range} to change value to accept value and return to previous menu level	Typical line (Display shows four lines at a time; cursor indicates active line)	
PUMP OPTIONS	SYSTEM PUMP	POST PRG TIME	2 minutes {1 to 60 minutes}	POST PRG TIME 2M ALWAYS ENABLED OFF SUMMER PUMP JOG: OFF	
		ALWAYS ENABLED	OFF {ON or OFF}		
		SUMMER PUMP JOG:	OFF {Day of week, MON, TUE, etc.}		
	LOCAL PUMP	DELTA TEMP ENAB	OFF {ON or OFF}	DELTA TEMP ENAB OFF DELTA TEMP 10° POST PRG TIME 2M ALWAYS ENABLED OFF	
		DELTA TEMP	10°F {0 to 50°F}		
		POST PRG TIME	2 minutes {1 to 60 minutes}		
		ALWAYS ENABLED	OFF {ON or OFF}		
	PUMP/VALVE OPTION	MASTER PUMP/VALVE REMAINS ON:	OFF {ON or OFF}	MASTER PUMP/VALVE REMAINS ON: OFF	
	FLOW PROVE:		10 seconds {10 to 240 seconds}	FLOW PROVE: 10S	
	NIGHT SETBACK	SETBACK ENTRY		1 {1 through 4}	SETBACK ENTRY 1 ENTRY IS OFF SETBACK 20°F SETBACK TIME
ENTRY IS			OFF {ON or OFF}		
SETBACK			20 °F {0 to 50°F}		
SETBACK TIME		START DAY		MON {SUN, MON, TUE, WED, THU, FRI, SAT}	START DAY MON TIME 10:00 PM END DAY FRI TIME 9:00 PM
		TIME		12:00 AM {Time, AM or PM}	
		END DAY		MON {SUN, MON, TUE, WED, THU, FRI, SAT}	
		TIME		12:00 AM {Time, AM or PM}	
OPTIONS		TEMP SCALE		°F {°F or °C}	TEMP SCALE °F KEY CLICK ON SKIP PASSW ON BRIGHTNESS 50%
	KEY CLICK		ON {ON or OFF}		
	SKIP PASSWORD		ON {ON or OFF}		
	BRIGHTNESS		50% {12, 25, 37, 50, 62, 75, 87, 100%}		

6

Control menus and adjustments *(continued)***Table 7** SETUP menus *(continued)* (see Table 9, page 30 for explanations)

Level 1   next item  to select	Level 2   next item  to select  back one level	Level 3   next item  to select  back one level	Default {Range}   to change value  to accept value and return to previous menu level	Typical line (Display shows four lines at a time; cursor indicates active line)
LOG/RUNTIME	RUN HOURS		Total time gas valve has been open	RUN HOURS 1240 DATA LOG ENTRY 327 SIZE 1000 BOILER CYCLES 5021
	DATA LOG ENTRY		Current entry in the log (see Table 9, page 30)	
	SIZE		The size of the data log	
	BOILER CYCLES		Number of times gas valve has been cycled on/off	
AUX FUNCTIONS	COMBUST AIR DAMPER	TYPE	LINKED/Common {LINKED/Common or INDEPENDENT}	TYPE: LINKED/Common IN USE? NO INPUT: J10B "DAMPER" {J10B DAMPER or J12B terminal 7} Change only when required to maintain existing wiring on boilers with an older edition of the firmware that used J10 B instead of J12 for this interlock. PROOF TIME 2:00 minutes {0 to 4 minutes}
		IN USE?	NO {YES or NO}	
		INPUT:	J10B "DAMPER" {J10B DAMPER or J12B terminal 7} Change only when required to maintain existing wiring on boilers with an older edition of the firmware that used J10 B instead of J12 for this interlock.	
		PROOF TIME	2:00 minutes {0 to 4 minutes}	
	ALARM SILENCE	IN USE?	YES {YES or NO}	ALARM SILENCE SWITCH IN USE? YES INPUT=J10B SPARE 2
		INPUT=	J10B SPARE 2 {see explanation, Table 9, page 30}	
	FAILSAFE MODES	RUN IN LOCAL IF: H-NET COMM LOST: LOW TEMP: TEMP LESS THAN	ON {ON or OFF} OFF {SUPPLY, SYS/DHW HEADER, RETURN, N/A, or OFF} 40°F {35 to 200°F}	RUN IN LOCAL IF: H-NET COMM LOST:OFF LOW TEMP: OFF TEMP < 40°F
	HEAT EXCHANGER	EXCHGR DELTA	100°F {1 to 120°F}	ADAPTIVE INPUT EXCHGR DELTA 120°F LIM->HALF RATE NO
		LIM->HALF RATE	NO {YES or NO}	
	SYSTEM CLOCK	TIME		See explanation, Table 9, page 30
DAY OF WEEK				
MONTH				
DAY			DAY FRI YEAR 2008 PRESS SEL TO SAVE	
YEAR				

6

Control menus and adjustments *(continued)*











Table 8 **ADVANCED SETUP** menus (see Table 9, page 30 for explanations)

To enter Setup: From STANDBY, hold  for 5 seconds. (If SKIP PASSWORD is set to OFF, you will have to enter the password.)

Then press  with cursor on **SETUP**.

Make sure there is no call for heat at the boiler before attempting to perform setup adjustments.

To return to STANDBY, press/release  until the display returns to standby, or turn boiler ON/OFF switch off, then on.

Level 1	Level 2	Level 3	Default {Range}	Typical line
 next item  to select	 next item  to select  back one level	 next item  to select  back one level	 to change value  to accept value and return to previous menu level	(Display shows four lines at a time; cursor indicates active line)
DISTRIBUTED CTRL	CONTROL		HNET	CONTROL H-NET H-NET MASTER YES LOCAL ADDRESS 255 MODBUS ADDRESS 1
	H-NET MASTER		YES (Display only, not changeable here) (MEMBER boilers will show NO, and addresses must be set from 2 to 16.)	
	H-NET ADDRESS		Master default = 255 (not changeable); Member default = 2 (Range = 2 to 16)	
	MODBUS ADDRESS		Default = 1; Range = 1 to 247	
MODULAR BOILER SET	ADD BOILER DELAY		10 minutes {0 to 15 minutes}	ADD DELAY TIME 10 MINUTES 0 SECONDS
	SHED BOILER DELAY		2 minutes {0 to 15 minutes}	SHED DELAY TIME 2 MINUTES 0 SECONDS
	MODULATE DELAY TIME		10 seconds {0 to 60 minutes}	MODULATE DELAY TIME 0 MINUTES 10 SECONDS
	MOD MAX - LAST FIRE		50% {25 to 100%}	STOP MOD MAX % 50
PID (FACTORY)			Factory set, not adjustable	PID (FACTORY)
FIRING MODE	FIRING MODE MASTER FIRST		TRUE ROTATION (TRUE ROTATION, LAST ON FIRST OFF, FIRST ON FIRST OFF) OFF (ON or OFF)	FIRING MODE TRUE ROTATION MASTER FIRST OFF
SENSORS	SENSOR # TYPE CALIBRATE		OUTSIDE {OUTSIDE, SUPPLY, RETURN, HEADER, 5, 6} TYPE Z {TYPE Z (10K), ON/OFF, TE6000 (1K), NONE} NO {YES or NO}	SENSOR ASSIGNMENTS SENSOR # OUTSIDE TYPE TYPEZ CALIBRATE? NO
	CALIBRATE		If YES is selected: (See explanation, Table 9, page 30)	PLACE A PRECISION 1K OR 10K RESISTOR ON CHANNEL # 1 TRIM OHMS = 120

6

Control menus and adjustments *(continued)*

Table 8 ADVANCED SETUP menus *(continued)* (see Table 9, page 30 for explanations)

Level 1 next item to select	Level 2 next item to select back one level	Level 3 next item to select back one level	Default {Range} to change value to accept value and return to previous menu level	Typical line (Display shows four lines at a time; cursor indicates active line)
4-20MA INPUT	4MA SETPOINT		50°F {50 to 220°F} (Not applied unless SETPOINT SOURCE is set to 4-20MA)	4MA SETPOINT 50°F 20MA SETPOINT 220°F BOILER START 4.11MA PRIORITY NORMAL
	20MA SETPOINT		220°F {50 to 220°F} (Not applied unless SETPOINT SOURCE is set to 4-20MA)	
	BOILER START		4.11 MA {3.7 to 4.3 MA} (Applies to either 4-20ma setpoint or modulation)	
	PRIORITY		Default = NORMAL {NORMAL or HIGH} NOTE: HIGH will cause the 4-20MA input to take control when a contact closes across the 4-20MA ENABLE terminals (J12A). To set to HIGH, make sure SETUP SETPOINTS SETPOINT SOURCE is set to AUTO.	
PASSWORD			Default = AAAAAA (Restore to default by pressing while turning ON/OFF switch to ON.) Password must be 6 characters long — the control will not accept blank characters.	
	CHANGE PASSWORD OLD:>?_____		Enter current password Press , enter old password using arrow keys and for each character.	CHANGE PASSWORD OLD: >?_____
	CHANGE PASSWORD NEW:>?_____		Enter new password Press , enter new password using arrow keys and for each character. Once all six places are filled, the display changes as shown below.	CHANGE PASSWORD OLD: AAAAAA NEW: >?_____
	ACCEPT PASSWORD		Once new password is entered, press to save or press to cancel.	CHANGE PASSWORD OLD: AAAAAA NEW: XXXXXX ACCEPT PASSWORD?
COMMUNICATIONS	BAUD		19200	COMMUNICATIONS BAUD 19200 PARITY EVEN MODEM NO
	PARITY		EVEN {EVEN or ODD}	
	MODEM INSTALLED		NO {YES or NO}	
LOAD DEFAULTS	FACTORY CAL?		NO {YES or NO}	FACTORY CAL? NO FACTORY RESET? NO
	FACTORY RESET?		NO {YES or NO}	
SYSTEM	FACTORY TEST		Press and the test will proceed.	FACTORY TEST LOAD FIRMWARE NO
	LOAD FIRMWARE		NO {YES or NO}	

6

Control menus and adjustments *(continued)*

Table 9 Setup menus — parameter explanations

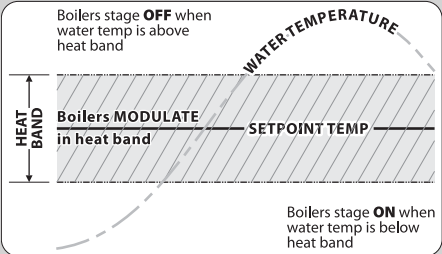
Menu item	Under ...	Explanation
FIRMWARE VERSION	VX.XX	All boilers in a multiple boiler application should preferably have the same firmware version to ensure consistency. If versions are different, all versions must be either version 2.0 or greater, or version 1.x.
# OF BOILERS	BOILERS	Display only — shows the number of boilers detected on the network for a HeatNet network only; displays the total number only on the Master boiler; displays “1” for MEMBER boilers or for any boiler not on a HeatNet network. The maximum number of boilers on a HeatNet network is 16.
LEAD BOILER #	BOILERS	Display only — always shows “1”
HEAT BAND	BOILERS	 <p>The heat band is the height of the modulating band. When the water temperature is between ½ the heat band above or below the setpoint temperature, boiler firing rate modulates. Boilers are at minimum input at the upper end of the band and maximum input at the lower end of the band. Boilers come on only if the water temperature is below the band. Boilers stage off when the water temperature is above the band.</p>
HEAT NET BOILERS	BOILERS	This line appears on the display only for a HeatNet Master boiler (boiler with a sensor connected to the SYS/DHW HEADER sensor input terminals). The line is <i>blank</i> on MEMBER boilers. If the number of boilers shown is less than the number of boilers on the HeatNet network, check the yellow light on the HeatNet connection port of each boiler. The yellow light will be ON if the communications port is successfully connected to the Master. The address of each recognized MEMBER boilers (addresses 2 up to 16), and begins with “1,” the address of the Master boiler.
LOCAL SETPT OR SYSTEM SETPT	SETPOINTS	Setpoint temperature controlled by the KN control. Local setpoint refers to boiler supply temperature. System setpoint appears if there is a sensor connected to the SYS/DHW HEADER sensor terminals. System setpoint refers to the header or DHW temperature. NOTE: If the boiler is operated by a Master control or by a remote control (building management system, 4-20ma control, etc.), this setpoint temperature only comes into play when the KN control is in override mode (such as by closing its Heat Demand, AA or T1, T2 terminals; or by the 4-20mA Enable if 4-20mA is set to Highest Priority).
OPERATE LIMIT	SETPOINTS	This is for boilers regulating header temperature instead of boiler supply temperature, or boilers operated by an external source, such as by a Master boiler on a HeatNet network or by external 4-20mA signal or closure on T1, T2 or AA. OPERATE LIMIT is the temperature at the boiler outlet that will cause the boiler control to shut down on high temperature limit. It must be high enough above the upper end of the heat band to avoid nuisance cycling. For boilers operating as stand-alone and regulating boiler supply temperature, this setting is not necessary, because the boiler shuts off when the SUPPLY temperature exceeds the top of the HEAT BAND. The maximum setting is 220°F. Example: If the boiler setpoint is 180°F, and the heat band is 30°F, the upper end of the heat band is $180 + 30/2 = 195^\circ\text{F}$. The limit band (see below) must be set at 10°F so the OP LIMIT setting can be: $195 + 10 = 205^\circ\text{F}$. The OP LIMIT cannot be higher than 220°F. The operating limit setting (OPERATE LIMIT) always limits boiler outlet water temperature, regardless of how the boiler is controlled (HeatNet member, 4-20ma control, stand-alone or other). The OP LIMIT BAND (see below) determines when the boiler begins to be forced to reduce input as the outlet temperature rises toward the limit setting.

6

Control menus and adjustments *(continued)*

Table 9 Setup menus — parameter explanations (continued)

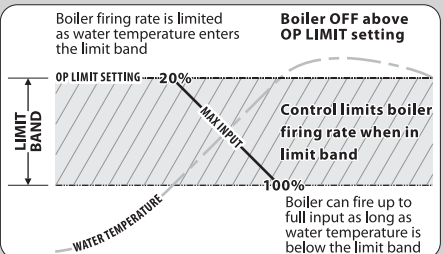
Menu item	Under ...	Explanation
OP LIM BAND	SETPOINTS	 <p>Boiler firing rate is limited as water temperature enters the limit band</p> <p>Boiler OFF above OP LIMIT setting</p> <p>OP LIMIT SETTING — 20%</p> <p>LIMIT BAND</p> <p>MAX INPUT</p> <p>Control limits boiler firing rate when in limit band</p> <p>100%</p> <p>Boiler can fire up to full input as long as water temperature is below the limit band</p> <p>WATER TEMPERATURE</p> <p>If the boiler outlet water temperature rises toward the OPERATE LIMIT setting, the KN control will begin to reduce the boiler's firing rate when the temperature gets within the limit band degrees F below the operating limit setting. At the lower end of the limit band, the boiler can fire up to maximum input (100%). By the time the temperature reaches the upper end of the band (the OP LIMIT setting), the boiler is limited to minimum input (20%).</p> <p>Example: If OPERATE LIMIT is set to 220°F and OP LIM BAND is set to 30°F, the boiler will begin to reduce firing rate when the SUPPLY temperature in the boiler exceeds 220° – 30° = 190°F. The boiler firing rate will be reduced to minimum when SUPPLY temperature reaches 220°F. The boiler will shut off if the SUPPLY temperature rises above 220°F.</p> <p>Restart — The boiler will not fire again until the SUPPLY temperature drops below the bottom of the OP LIM BAND. For the example above, the boiler will be allowed to come on again below 190°F.</p> <p>The limit band reduces the likelihood of short cycling on boilers controlled by a master control or a remote control by reducing boiler maximum allowable firing rate as the temperature rises toward the limit setting. Make sure the lower end of the limit band is above the upper end of the heat band.</p>
SETPOINT SOURCE	SETPOINTS	<p>Specifies where the space heating setpoint temperature comes from:</p> <p>AUTO:</p> <p>With AUTO selected, the KN HeatNet control determines the setpoint (using local setpoint, outdoor reset or SYS/DHW HEADER temperature setpoint).</p> <p>4-20mA:</p> <p>If 4-20mA is selected, the KN control determines setpoint based on the signal it receives at the 4-20ma terminals on the connection board.</p> <p>There must be a contact closure across the 4-20mA ENABLE terminals (J12A) for the boiler to respond to the 4-20mA signal.</p> <p>The temperature and boiler start settings are set in the ADVANCED SETUP 4-20mA INPUT menus. (The menu will automatically transfer to the 4-20mA INPUT menus if 4-20mA is selected for SETPOINT SOURCE.)</p> <p>If the HEAT DEMAND input is closed, the H-NET control will use the SYSTEM SETPT or LOCAL SETPT temperature to control the boiler(s) if the 4-20ma signal is below 5ma. Once the current exceeds 5ma, the setpoint is determined from the ma signal value. (This method may be thought of as a backup in the event the 4-20ma signal is lost.)</p> <p>If the HEAT DEMAND input is open, the 4-20ma signal will start the H-NET system once the current exceeds 5ma. Temperature is controlled to the setpoint determined by the ma signal value.</p>
OA RESET	OUTDOOR AIR	<p>Set to "ON" to enable resetting the SUPPLY temperature (or SYS/DHW HEADER temperature) based on outside air temperature. This requires an outdoor sensor when enabled.</p> <p>Set to "OFF" to disable outdoor reset.</p>
WARM WEATHER SD	OUTDOOR AIR	<p>When this setting is YES, the boiler will shut down when outdoor temperature is at or above WWS SETPOINT. The outside temperature must drop at least 2°F below the WWS SETPOINT for the boiler to come on again.</p> <p>Set to NO to disable.</p>

6

Control menus and adjustments *(continued)*

Table 9 Setup menus — parameter explanations (continued)

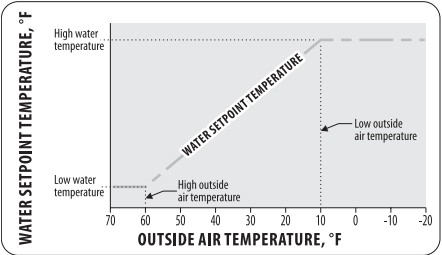
Menu item	Under . . .	Explanation
WWS SETPOINT	OUTDOOR AIR	<p>The boiler and its circulator shut down when the outside air temperature is above WWS SETPOINT if outdoor air reset is enabled (ON). This requires an outdoor sensor when enabled.</p> <p>The differential is 2°F; i.e., the boiler will shut off if the outdoor temperature is equal to or greater than OUTDOOR AIR setting. The outdoor temperature must drop 2°F below OUTDOOR AIR setting for the boiler to turn back on.</p> <p>If the OA OVR input is closed, outdoor reset and warm weather shutdown are overridden. The boiler will run at LOCAL/SYSTEM SETPOINT. This function can be used to operate the HeatNet system at a fixed temperature (equal to the LOCAL SETPT or SYSTEM SETPT), for applications such as DHW heating.</p>
LOW WATER AT HIGH OA TEMP HI WATER AT LOW OA TEMP	OUTDOOR AIR SET OA SETPTS	 <p>These temperatures determine the reset curve for supply water temperature. High water at low outside air means the design water temperature for maximum load (at ODT, or outside design temperature for the installation). The other end of the reset curve is the low water temperature at high outside air temperature. The low water temperature is generally equal to room temperature, meaning no heat input to the space would occur below this outside air temperature.</p>
POST PRG TIME	PUMP OPTIONS SYSTEM PUMP	<p>SYSTEM PUMP settings apply to a system pump if it is to be cycled by the HeatNet control.</p> <p>Connect a relay or starter for the system pump to the SYSTEM PUMP terminals (J13). DO NOT directly connect the pump motor with these terminals. They are for pilot duty only.</p> <p>To prove system flow before boiler operation, install a flow proving switch across SYSTEM WTR FLOW terminals (J11A). Place a jumper on these terminals if system flow proving is not used.</p> <p>POST PRG TIME keeps the pump running for the specified time after call for heat is completed, allowing distribution of residual heat to the system.</p> <p>WARNING — The system must be equipped with a bypass pressure regulator or other means to prevent dead-heading if system valves close when call for heat is completed.</p>
ALWAYS ENABLED	PUMP OPTIONS SYSTEM PUMP	<p>If enabled, the system pump remains on constantly. If pump is constant, DELTA TEMP and POST PRG TIME have not effect.</p> <p>NOTE: The system pump will shut down if outdoor air reset is enabled and the outside temperature is above OA SETPOINT (summer mode operation).</p> <p>WARNING — The system must be equipped with a bypass pressure regulator or other means to prevent dead-heading if system valves close when call for heat is completed.</p>
SUMMER PUMP JOG:	PUMP OPTIONS SYSTEM PUMP	<p>This option is available to prevent the pump from seizing during long idle periods. Enable the option to have the system pump operated once per week (specify the day in setup). The pump will cycle on at 12:00 AM on the day specified. It will operate for a time equal to the time set for POST PRG TIME.</p> <p>WARNING — The system must be equipped with a bypass pressure regulator or other means to prevent dead-heading if system valves close when call for heat is completed or during summer or outdoor air shutdown.</p>
DELTA TEMP ENAB	PUMP OPTIONS LOCAL PUMP	<p>The boiler pump can be set to run after boiler shutdown to distribute residual heat to the heating system. Delta enable causes the boiler pump to run until the temperature difference between boiler inlet and outlet is less than DELTA TEMP (see below). The pump will continue to run an additional period after this for the amount of time specified in PURGE TIME (below).</p>

6

Control menus and adjustments *(continued)***Table 9** Setup menus — parameter explanations (continued)

Menu item	Under . . .	Explanation
DELTA TEMP	PUMP OPTIONS LOCAL PUMP	When DELTA ENABLE (above) is set to "ON," the boiler pump will run until the temperature difference across the boiler is less than DELTA TEMP. (The pump will run an additional time equal to the PURGE TIME.) An inlet temperature sensor is required.
POST PRGE TIME	PUMP OPTIONS LOCAL PUMP	The boiler pump can run after boiler shutdown to distribute heat remaining in the boiler water. POST PRGE TIME sets how long the boiler pump will run. (Also see DELTA TEMP, above.) NOTICE: For systems that shut off flow valves (such as zone valve systems) when the call for heat is satisfied, this option must be set to "0" to prevent dead-heading the pump.
ALWAYS ENABLED	PUMP OPTIONS LOCAL PUMP	If ALWAYS ENABLED is set to "YES," the boiler circulator never turns off.
MASTER PUMP/VALVE REMAINS ON:	PUMP OPTIONS PUMP/VALVE OPTION	If set to "ON," the master control in the network will keep its pump contacts closed (running its pump and/or control valve) if no other boilers are operating. This is used to prevent dead-heading system flow.
FLOW PROVE	PUMP OPTIONS FLOW PROVE	This is the time allowed for flow to prove (closure across the J11B "WTR FLW" terminals. It can be increased to allow time for slow-opening valves to open.
SETBACK ENTRY	NIGHT SETBACK	Setback entry is the designator for the setback operation. Up to four (4) setback operations can be programmed.
ENTRY IS	NIGHT SETBACK	Select "ON" to enable a setback operation. Then program the times, days and setpoint. The setpoint assigned will override the KN control's setpoint when setpoint is controlled locally. It will not override 4-20ma control or building management control.
SETBACK	NIGHT SETBACK	This is the reduction in local (or system) setpoint temperature during the specified period.
SETBACK TIME	NIGHT SETBACK	Enter the start and end days and the times for start/end.
TEMP SCALE	OPTIONS	Select Fahrenheit or Centigrade.
KEY CLICK	OPTIONS	If activated, the control beeps when a key is pressed.
SKIP PASSWORD	OPTIONS	The control can be programmed such that a password is required to change settings. Setting this to "ON" disables the password. If SKIP PASSWORD is OFF, then a password is required to enter the setup menus. Default password = AAAAAA (Restore to default by pressing  while turning ON/OFF switch to ON.) Password must be 6 characters long — the control will not accept blank characters.
BRIGHTNESS	OPTIONS	Adjust the brightness of the display.
RUN HRS	LOG/RUNTIME	Displays the total time the boiler gas valve has been open.
DATA LOG ENTRY	LOG/RUNTIME	Displays the current entry in the data log (see Figure 12, page 41).
SIZE	LOG/RUNTIME	Displays the current number of entries in the data log.
BOILER CYCLES	LOG/RUNTIME	Displays the number of times the boiler gas valve has been cycled on, then off. It does not include failed ignition attempts.

6

Control menus and adjustments *(continued)*

Table 9 Setup menus — parameter explanations (continued)

Menu item	Under . . .	Explanation
TYPE	AUX FNCTIONS COMBUSTION AIR DAMPER	This option allows selecting either a single, master combustion air damper or an individual, independent damper for each boiler. Select LINKED/Common if only one damper is present. If the damper fails to prove, all boilers in the system are disabled. The control will re-attempt to prove the damper every 10 minutes. Select INDEPENDENT to operate an independent damper with each boiler. If a boiler's damper fails to prove, the control will shut down only that boiler, and will retry proving every 10 minutes.
IN USE?	AUX FNCTIONS COMBUSTION AIR DAMPER	Enter YES to enable the combustion air damper interlock. If not using the combustion air damper, make sure the damper proving terminals on the HeatNet control board are jumpered. NOTE: If the damper is not proven, the HeatHet control will retry proving every 10 minutes.
INPUT	AUX FNCTIONS COMBUSTION AIR DAMPER	This indicates which terminals are connected to the combustion air damper proving switch.
PROOF TIME	AUX FUNCTIONS COMBUSTION AIR DAMPER	Set proof time long enough to be sure the combustion air damper can open and activate its end switch.
RUN IN LOCAL IF: H-NET COMM LOST	AUX FUNCTIONS FAILSAFE MODES	When set to NO, the boiler will only operate if activated by an override input (AA, 4-20mA enable, or T1/T2). When set to YES, the boiler will revert to LOCAL operation, controlling its outlet water temperature to the LOCAL SETPOINT setting. NOTE: The control will wait 10 minutes after losing communications with the HeatNet master before switching to local operation.
RUN IN LOCAL IF: LOW TEMP:	AUX FUNCTIONS FAILSAFE MODES	This function can automatically start the boiler (or boilers, via the Master) if water temperature drops below the value set for TEMP LESS THAN. This function can be used to provide automatic freeze protection. Once the temperature (TEMP LESS THAN value) is reached, the boiler (or boilers) will shut off. Select which sensor to monitor: SUPPLY, RETURN or HEADER.
RUN IN LOCAL IF: TEMP LESS THAN	AUX FUNCTIONS FAILSAFE MODES	Set the minimum allowable temperature for the location selected in LOW TEMP, above.
EXCHGR DELTA	AUX FUNCTIONS HEAT EXCHANGER	This feature is active if LIM->HALF RATE is set to YES (see following explanation). When the temperature rise through the boiler (SUPPLY minus RETURN temperatures) rises higher than the value of EXCHGR DELTA, the control immediately begins limiting the boiler firing rate to one half of the called for rate. This quickly reduces the boiler output to avoid short cycling on limit. The control will return to normal operation once the boiler temperature rise reduces to 10°F less than the value set for EXCHGR DELTA.

6

Control menus and adjustments *(continued)***Table 9** Setup menus — parameter explanations (continued)

Menu item	Under . . .	Explanation
LIM->HALF RATE	AUX FUNCTIONS HEAT EXCHANGER	Set this feature to YES to cause the control to automatically reduce the boiler firing rate to one half the called for value if the temperature rise through the boiler exceeds the maximum value desired. This maximum temperature rise is EXCHGR DELTA. NOTE: This function can be used to prevent short cycling if the header temperature can drop quickly, causing the boiler to try increasing boiler supply temperature to meet the apparent demand increase. Quick header temperature drop can occur, for example, when boilers are equipped with slow-opening valves — the valve begin to allow flow as they open, but the boiler can't fire until they are fully open and make their end switches. NOTE: DISPLAY — When this feature is enabled, the display will be different from normal. In RUN mode, the display will show "1/2 INPUT *" instead of RUN %. The "*STATUS" screen will show "ADAPTIVE IN" over the START and STOP times.
SYSTEM CLOCK		Set the system clock (time, day of week, month, day and year) on start-up and after any power outage to ensure the data log time stamp information will be accurate.
CONTROL	ADVANCED SETUP DISTRIBUTED CTRL	This is not adjustable. It only displays that the control is a HeatNet (H-Net) control.
H-NET Master	ADVANCED SETUP DISTRIBUTED CTRL	This is not adjustable. It will automatically say YES for the Master boiler and NO for a MEMBER boiler. (The Master boiler is the boiler with a sensor connected to the SYS/DHW HEADER terminals.)
H-NET ADDRESS	ADVANCED SETUP DISTRIBUTED CTRL	Assign each MEMBER boiler a unique address, any value from 2 through 16. The Master boiler H-NET address is automatically set to 255. (The master boiler is automatically recognized because it is the one with a sensor wired to its SYS/DHW HEADER terminals.)
MODBUS ADDRESS	ADVANCED SETUP DISTRIBUTED CTRL	This is used only when the boilers are regulated by a building management system, using MODBUS, BACNET or LONWORKS. Assign each member boiler AND the Heat Net master boiler a unique address, any value from 1 to 247.
ADD BOILER DELAY	ADVANCED SETUP MODULAR BOILER	This is the minimum wait time before an additional boiler can fire when called on by the master boiler control.
MODULATE DELAY TIME	ADVANCED SETUP MODULAR BOILER	The boiler will remain at minimum fire when first starting until this amount of time has elapsed.
MOD MAX - LAST FIRE	ADVANCED SETUP MODULAR BOILER	This sets the maximum firing percentage for boilers during times that some boilers are not firing. It limits input of the boilers to keep them as efficient as possible. Once all boilers are started (during high heat demand periods), this restriction is removed, and all boilers can fire up to maximum input. Once any boiler is dropped offline, the restriction is applied again.
ROTATION	ADVANCED SETUP FIRING MODE	Select the rotation method. TRUE ROTATION (or TRUE RUNTIME ROTATION) attempts to fire all boilers an equal amount of time. FIRST ON FIRST OFF jogs between boilers to balance usage. LAST ON FIRST OFF maintains the same rotation sequence at all times.
Master FIRST	ADVANCED SETUP FIRING MODE	Set this to "ON" to always start the master boiler first, regardless of the rotation scheme selected.
SENSOR#	ADVANCED SETUP SENSORS	The HeatNet control can be connected to up to six sensors: OUTSIDE, SUPPLY, RETURN HEADER, and two user-selectable inputs (number 5 or number 6).

6

Control menus and adjustments *(continued)***Table 9** Setup menus — parameter explanations (continued)

Menu item	Under . . .	Explanation
TYPE	ADVANCED SETUP SENSORS	<p>For each sensor, select either TYPE Z (10K), ON/OFF, TE6000 (1K), or NONE.</p> <p>Type Z is a thermistors sensor (as supplied by Hydrotherm). Type Z sensors are NTC thermistors, 10Kohms at 77 °F, 335.67 Kohms at -40 °F, 185 Kohms at 150 °F, +/- 1 °F, -40 to 140 °F.</p> <p>ON/OFF looks for an external dry contact closure.</p> <p>TE6000 is a 1 Kohm wire-wound sensor.</p> <p>NONE means no sensor is connected to the terminals.</p>
CALIBRATE ?	ADVANCED SETUP SENSORS	<p>Use this function only if the response to a sensor indicates the control calibration may be off.</p> <p>Calibrate Type Z sensors inputs by attaching a 10Kohm precision resistor across the sensor terminals. (Use a 1Kohm precision resistor for TE6000 elements.)</p> <p>Select "YES" after "CALIBRATE."</p> <p>The control will measure the resistance and establish a trim value (in ohms) for the sensor input.</p> <p>The control display will show the trim value setting.</p> <p>The trim value must not exceed +/- 200 ohms. If it does, verify that the resistor is correctly connected. If so, the sensor input is bad. Contact Mestek for recommended action.</p> <p>If the trim setting is acceptable, press the SELECT key to accept.</p> <p>The display will show, "TRIM VALUE SET!"</p> <p>After a slight delay, the display will return to the sensors menu.</p>
4mA SETPOINT 20mA SETPOINT	ADVANCED SETUP 4-20mA INPUT ADVANCED SETUP 4-20mA INPUT	<p>The 4mA SETPOINT and 20mA SETPOINT establish the temperature range when the boiler/ system is operated with a remote 4-20mA setpoint.</p> <p>Set the 4mA SETPOINT to the starting temperature.</p> <p>Set the 20mA SETPOINT to the maximum desired temperature (at max signal of 20 mA).</p> <p>Any signal between 4 and 20 mA will change the setpoint proportionally between the upper and lower temperature values.</p> <p>Example: 4mA SETPOINT = 140 °F / 20mA SETPOINT = 200 °F — If the signal is at 4 mA, the setpoint temperature will be 140 °F; at 20 mA, the setpoint temperate will be 200 °F.</p> <p>At 12 mA, the setpoint temperature will be: $140^{\circ} + (200^{\circ} - 140^{\circ}) \times (12\text{mA} - 4\text{mA})/16\text{mA} = 140^{\circ} + (60^{\circ} \times 8/16) = 140^{\circ} + 30^{\circ} = 170^{\circ}\text{F}$.</p> <p>At 15 mA, the setpoint temperature will be: $140^{\circ} + (200^{\circ} - 140^{\circ}) \times (15\text{mA} - 4\text{mA})/16\text{mA} = 140^{\circ} + (60^{\circ} \times 11/16) = 140^{\circ} + 41^{\circ} = 181^{\circ}\text{F}$.</p> <p>NOTE: Under SETUP SETPOINTS, the SETPT SOURCE must be set to 4-20mA. The current must be above the BOILER START value, the 4-20mA ENABLE contact must be closed for remote setpoint operation to function.</p>

6

Control menus and adjustments *(continued)***Table 9** Setup menus — parameter explanations (continued)

Menu item	Under . . .	Explanation
BOILER START	ADVANCED SETUP 4-20mA INPUT	This sets the signal current at which the boiler will start/shut off. The boiler will start when the current is approximately 0.10 mA above the setting. The boiler will shut off if the current falls below the setting. Example: 4mA SETPOINT = 3.8 mA — the boiler will start at 3.9 mA and shut at or below 3.7 mA.
PRIORITY	ADVANCED SETUP 4-20mA INPUT	When this is set to NORmAL, the priority of a 4-20mA input (when enabled by closure across the 4-20mA enable terminals) is in the normal order: AA (high fire), HEAT DEmAND, HeatNet, 4-20mA, T1/T2. When set to HIGHEST, the priority sequence is changed to give 4-20mA the highest priority (above AA). NOTE: The SETPOINT SOURCE (under SETUP SETPOINTS) must be set to AUTO for HIGHEST priority to work. The control cannot be placed in LOCAL mode if this PRIORITY is enabled and active.
CHANGE PASSWORD	ADVANCED SETUP PASSWORD	Use to set/change a password. NOTE: You can reset the password to the default value (AAAAAA) by turning the ON/OFF switch to OFF. Then hold down the BACK key as you turn the ON/OFF switch to ON. The password is only required if the control is setup with SKIP PASSWORD set to NO, found under: SETUP OPTIONS SKIP PASSWORD .
BAUD	ADVANCED SETUP COMMUNICATIONS	9600
PARITY	ADVANCED SETUP COMMUNICATIONS	Select even or odd as required by communications port used.
MODEM	ADVANCED SETUP COMMUNICATIONS	Select "YES" only if a modem is installed.
LOAD DEFAULTS	ADVANCED SETUP	Load the factory defaults when you want to be sure nothing has been changed or after you have loaded new firmware. 1. Disconnect wires to the Heat Demand terminals and any other remote operation wiring. There must be no call for heat during the process. 2. Navigate the control display to "LOAD DEFAULTS." 3. To restore factory calibration settings or factory settings, section either of the options and select "YES" for the prompt, "ARE YOUR SURE?"

6

Control menus and adjustments *(continued)***Table 9** Setup menus — parameter explanations (continued)

Menu item	Under . . .	Explanation
FIRMWARE VERSION (UPDATE CONTROL?)	ADVANCED SETUP SYSTEM	<p>The firmware version in the control must match the version in this manual in order to ensure accuracy of the installation/operation information. The control displays the firmware version number when SETUP is accessed. To update the control's firmware, obtain a disk from Hydrotherm or download the current file from the Hydrotherm website.</p> <p>For networked boilers, all must have version 1.x, or all must have version 2.x. It is preferable for all boilers to have the same version number for consistency. If replacing a boiler control or adding a new boiler to a network, update the firmware on all boilers, particularly if any or all existing boilers have firmware 1.x (not 2.x).</p> <ol style="list-style-type: none"> 1. Disconnect wires to the Heat Demand terminals and any other remote operation wiring. There must be no call for heat during the process. 2. Record all setup information for the application before proceeding (use SETUP WORKSHEET, page 48). 3. Insert the Firmware Update Program disk (or download executable file) into the computer. The program will auto-start if on disk (manually execute the program if working from a file on the computer). 4. Follow the instructions as the program progresses. (If a separate option is provided to install USB drivers, do so before running the firmware update program.) 5. Plug a USB cable into the control connection board, with the other connected to the computer. THE CABLE MUST BE CONNECTED BEFORE STARTING THE FIRMWARE UPDATE PROGRAM. 6. Follow the program instructions for selecting the correct com port and firmware file. 7. Navigate to the KN control ADVANCED SETUP menu, to "SYSTEM." 8. Move the cursor to "LOAD FIRMWARE." 9. NOTICE: The firmware must be downloaded now for the KN control to function again. 10. Return to the computer. Follow the firmware program instructions to begin downloading the firmware to the KN control. 11. If the download is interrupted or fails, turn the boiler ON/OFF switch OFF, then ON. Restart the firmware download program to start the download. (The boiler will appear unresponsive during this time because it is waiting for the download to take place.) 12. When the download is complete, the boiler will power cycle. The display should show STANDBY. 13. If the firmware does not load correctly, the display will remain blank. Try running the firmware program again. 14. Check that the boiler performs properly.

6

Control menus and adjustments *(continued)*

Calibration of firing rates (blower speeds)

This section describes use of the **KN** HeatNet control to set blower speeds for minimum input (MIN OUTPUT), maximum input (MAX OUTPUT) and pilot ignition period (IGNITION).

WARNING Follow all instructions in the **KN** Series Gas Boiler Installation and Operation Instructions manual to install and adjust the boiler before proceeding with any of the procedures below. Failure to comply could result in severe personal injury, death or substantial property damage.

Entering calibration mode

WARNING Electrical shock hazard — Use caution when working around electrical components in the boiler. Exposed line voltage electrical connections could cause a severe shock. Failure to comply could result in severe personal injury or death.

1. Turn off all call for heat inputs or disconnect wires, if necessary, to ensure there are not heat calls during the procedures.
2. Disconnect the HeatNet cable from the boiler if necessary to ensure there is no call for heat from the MASTER boiler.
3. Turn the boiler ON/OFF switch to ON.
4. Open the boiler front door and locate the control board.
5. Find the calibration switch, located on the lower left corner of the control board. It is labeled, "NORM" and "CAL."

Figure 11 Calibration switch (on lower left corner of control board) — shown with reduced board component detail for clarity

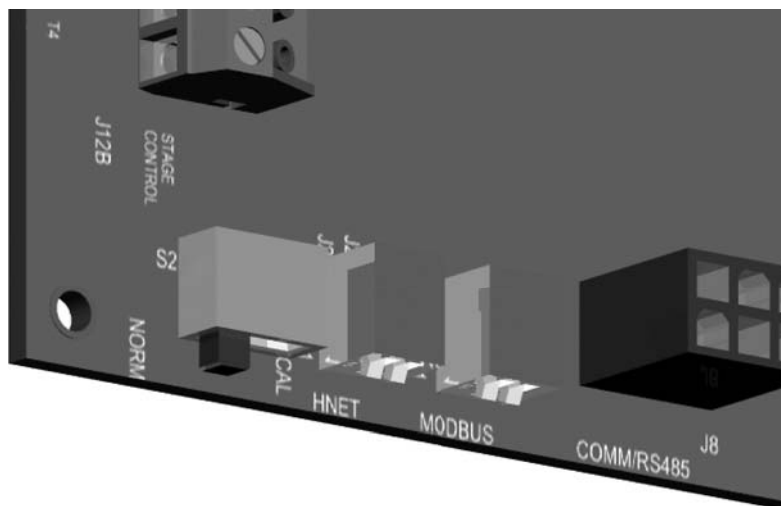

1. Slide the calibration switch to the right to "CAL."

Calibration mode display

1. The **KN** HeatNet control is now in calibration mode, and will show "CALIBRATE" on the display.
2. The first screen will show the following. The value shown for temperature is the SYSTEM (or LOCAL) setpoint. MEMBER boilers will show LOCAL SET instead of SYSTEM SET.

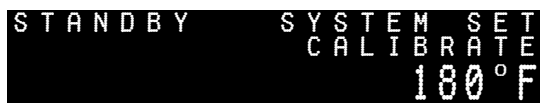

3. Press the DOWN key to navigate through the following displays.

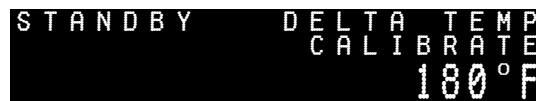

This screen is for display only, and shows the setting for DELTA TEMP (see SETUP instructions on previous pages).

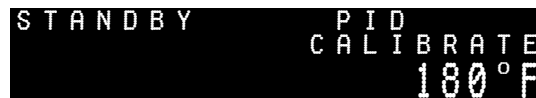

This screen is for display only.



Press SELECT to change the value. The number will begin flashing. Use the arrow keys to change. Then press SELECT to save the setting. The value is saved when the number stops flashing.



Press SELECT to change the value (IGNITION rate must be between 20% and 40%). The number will begin flashing. Use the arrow keys to change. Then press SELECT to save the setting. The value is saved when the number stops flashing.



Press SELECT to change the value. (Minimum must be at least 20%.) The number will begin flashing. Use the arrow keys to change. Then press SELECT to save the setting. The value is saved when the number stops flashing.



Additional screens follow, and show information only for: SUPPLY (supply temperature value) and HEADER (header temperature value).

NOTICE

When a setting is blinking, you have 5 minutes to change the value with the arrow keys, or the control will restore the original value and stop blinking.

4. Slide the calibration to NORM to return the boiler to normal operation. Reconnect wires as needed.

7

Boiler operation and status display

Starting the system

WARNING **Follow the Boiler manual** — Install the boilers according to the **KN Series Gas Boiler Installation & Operating Instructions** manual before attempting to set up the control system. Perform the start-up and adjustment procedures in the manual before proceeding. Failure to comply could result in severe personal injury, death or substantial property damage.

NOTICE **FAULTS** — Clear any faults that appear on the display and make sure to correct the cause before proceeding. You can silence the alarm by applying a jumper across J10B SPARE terminals.

1. Place the LOCAL/REMOTE switch on the MASTER boiler (or stand-alone boiler) to LOCAL.
2. Place MEMBER boiler LOCAL/REMOTE switches to REMOTE.
3. Start the MASTER boiler first. Turn the MASTER boiler ON/OFF switch to ON.
4. The HeatNet control will initialize and show the standby screen unless there is a call for heat.
5. Start a call for heat. As soon as the control receives a call for heat, it will show the setpoint temperature bar, as below:



6. The graphic below explains the temperature bar. You will see the header or supply temperature change as boilers add heat to the system or demand changes.

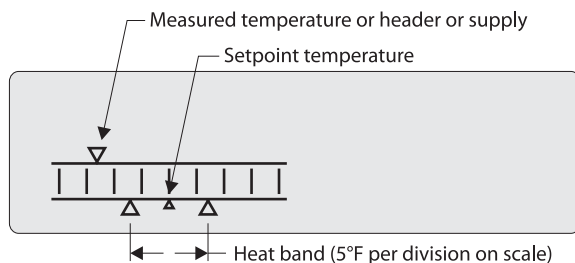

7. The upper left of the display will show boiler condition (prepurge, etc.) as the boiler begins its cycle. After the boiler begins firing, the screen will show RUN % as above.
8. After the ADD BOILER DELAY time has elapsed, the next boiler will fire. The MASTER boiler display will show the START and STOP times. The START time counts down on the display. When the next boiler starts, a 2 will shown in the BLRS FIRING list. If this doesn't happen, the water temperature may have entered the HEAT BAND, so no additional heat is needed.
9. Watch the temperature response as boilers are added. The HeatNet control will attempt to bring the controlled temperature to the setpoint by modulating boilers to meet the demand.
10. If temperature tends to overshoot too much, adjust the ADD BOILER DELAY, STOP BOILER DELAY, and MODULATE DELAY settings in the ADVANCED SETUP menu to adapt behavior to the system.
11. Member boiler displays will show RUN % in the upper left of the display.

NOTICE The AA terminals are the high fire override. If closed on a MEMBER boiler, the boiler runs independently of the MASTER, because AA takes priority. If AA is closed on the MASTER boiler, the HeatNet network shuts down, and only the master boiler fires (at high fire). If using a diverter valve for a DHW tank, it is recommended that you use a MEMBER boiler, activated with its AA terminals. This way, the HeatNet and heating loop will still be under control.

8

Troubleshooting

Accessing the data log

- The log stores major events that have occurred during the operation of the **KN** series boiler. These events include:
 - Faults
 - Boilers starting and stopping
 - Pump activity
 - Valve activity (main and pilot)
 - Input (Type of call for heat)
- Additional information recorded includes:
 - Time of event (Time stamp)
 - The # of the event in the log
 - The supply water temperature
 - The setpoint
 - The outside air temperature
 - The actual PWM % of modulation
 - All of the boilers that are firing (Master)
- See Figure 12 for an explanation of the data on the screen.
- Notice the snapshot #. This is a log entry, of which there are up to 1,000. As soon as you enter the view log screen, it displays the last log entry the **KN** series boiler recorded.
- To view previous entries, press the DOWN arrow key.
- If you pressed the UP arrow key instead, you would have been taken to the very first entry. The log entries form a continuous ring of entries. You can verify this by observing the time stamp as you cycle through the entries.
- Once the log is full (1,000 entries), pressing the UP arrow key will show the oldest entry and no longer take you to the first entry. The log cannot be cleared and is a continuous record of 1000 entries. Older entries are overwritten.
- To exit the log, press the **BACK** key.

NOTICE Boiler N on display — The display can only show up to 7 boilers, and this information only appears on the MASTER boiler display. To view boilers above number 7, you will need the Boiler Control Pro software.

Figure 12 Accessing and using the Log

Enter Setup: From STANDBY, hold **BACK** for 5 seconds. Then press **DOWN** until the cursor points to VIEW LOG.
 Press **SELECT** with the cursor on VIEW LOG.
 The screen will now show the most recent entry in the log.
 Use the arrow keys to scroll through the log entries.

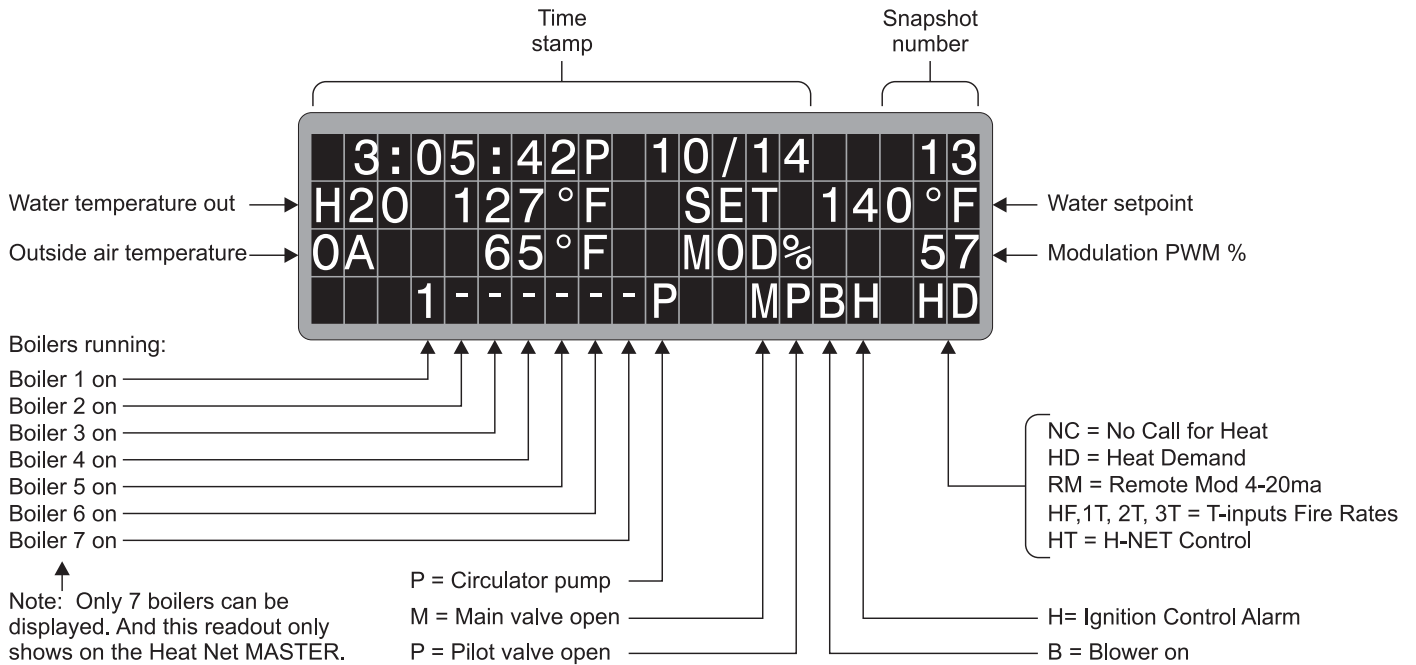

8

Troubleshooting *(continued)*

Fault indications

The HeatNet control monitors both boiler and external interlocks, and will shut down the boiler and display a fault code when a problem occurs. See Table 10 for details.

WARNING Some faults will cause the control to shut down the boiler or system and display the message. **CALL FACTORY.** Should this message appear, immediately contact Hydrotherm for assistance. **DO NOT** attempt to correct the condition without discussing the issue with the factory. Failure to comply could result in severe personal injury, death or substantial property damage.

Table 10 Status screen fault displays — when fault is tripped, display will show fault message, beep and close the alarm contact (for remote alarm); the fault displays for a second, then is followed by the time the fault occurred. The fault and time toggle once per second until the condition is corrected. NOTE: Momentary closure across J10B terminals ALARM SILENCE will silence the alarm.

FAULT EVENT & INTERLOCK TERMINALS	CAUSE/Discussion	DISPLAY	Action required to reset from fault
AIR SWITCH (BLOWER)	Occurs if the blower remains in prepurge longer than two minutes. The boiler is shut down until the fault is corrected. The display continues showing the SUPPLY, HEADER or other temperature, whichever had been selected for display. The temperature shown is the value detected at the sensor listed.	FAULT SUPPLY AIR SWITCH (BLOWER) 168 °F	Automatically resets control after external limit closes
COMBUST AIR DAMPER (J12B, terminals 7 & 8)	Occurs if closure isn't detected across J12B terminals 7 and 8 within the allowable time after the damper is activated via the J13 BOILER3/DAMPER contact. LINKED/Common damper operation (single, common damper): The system is shut down until the fault is corrected, but attempts a restart every 10 minutes. INDEPENDENT damper operation (a damper for each boiler): The individual boiler is shut down until the fault is corrected and the ON/OFF switch is cycled. The display continues showing the SUPPLY, HEADER or other temperature, whichever had been selected for display. The temperature shown is the value detected at the sensor listed.	FAULT SUPPLY COMBUSTION AIR DAMPER 168 °F	MASTER boiler — Automatically resets control after external limit closes MEMBER boiler or stand-alone boiler — Requires cycling of the boiler ON/OFF switch
FLOW SWITCH ERROR (J11B, WTR FLW)	Occurs on failure to close of a flow switch connected to J11B WTR FLW terminals. The boiler will restart every 10 minutes, attempting to prove flow. The display continues showing the SUPPLY, HEADER or other temperature, whichever had been selected for display. The temperature shown is the value detected at the sensor listed.	FAULT SUPPLY WATER FLOW SWITCH 168 °F	Automatically corrects if flow is proven
GAS PRESSURE (J11A, GAS PR)	Occurs on opening of gas pressure switches connected to J11A GAS PR terminals. The high and low gas pressure switches are wired in series. Opening of either switch will cause this fault. The boiler is shut down until the fault is corrected. The display continues showing the SUPPLY, HEADER or other temperature, whichever had been selected for display. The temperature shown is the value detected at the sensor listed.	FAULT SUPPLY GAS PRESSURE 168 °F	Automatically resets control after condition is corrected

8

Troubleshooting *(continued)***Table 10** Status screen fault displays *(continued)*

FAULT EVENT & INTERLOCK TERMINALS	CAUSE/Discussion	DISPLAY	Action required to reset from fault
HIGH LIMIT (J5, HIGH LIMIT)	Occurs on opening of an external limit connected to J5 HIGH LIMIT terminals. The boiler is shut down until the fault is corrected. The display continues showing the SUPPLY, HEADER or other temperature, whichever had been selected for display. The temperature shown is the value detected at the sensor listed.	FAULT SUPPLY HIGH LIMIT 168° F	Automatically resets control after external limit closes
IGNITION CTRL ALARM	Occurs when the HeatNet control receives an alarm signal from the ignition control. This could occur on ignition failure, air proving switch error, or any other fault that triggers the ignition control's alarm circuit. The boiler is shut down until the fault is corrected. The display continues showing the SUPPLY, HEADER or other temperature, whichever had been selected for display. The temperature shown is the value detected at the sensor listed.	FAULT SUPPLY IGNITION CTRL ALARM 168° F	Automatically resets control after external signal ends
INTERLOCK SPARE 3 (J11A, SPARE 3)	Occurs on opening of an external device connected to J11A SPARE 3 terminals. The boiler is shut down until the fault is corrected. The display continues showing the SUPPLY, HEADER or other temperature, whichever had been selected for display. The temperature shown is the value detected at the sensor listed.	FAULT SUPPLY INTERLOCK SPARE 3 168° F	Automatically resets control after condition is corrected
INTERLOCK SPARE 4 (J11B, SPARE 4)	Occurs on opening of an external device connected to J11B SPARE 4 terminals. The boiler is shut down until the fault is corrected. The display continues showing the SUPPLY, HEADER or other temperature, whichever had been selected for display. The temperature shown is the value detected at the sensor listed.	FAULT SUPPLY INTERLOCK SPARE 4 168° F	Automatically resets control after condition is corrected
IRI ALARM	Occurs when the HeatNet control receives an alarm signal from the gas valve. The boiler is shut down. If the condition isn't corrected within one minute, CALL FACTORY appears on the display. Check the gas valve if this fault appears. The display continues showing the SUPPLY, HEADER or other temperature, whichever had been selected for display. The temperature shown is the value detected at the sensor listed.	FAULT SUPPLY IRI ALARM 168° F	Requires cycling the boiler ON/OFF switch to reset after condition is corrected
LOW WATER CUTOFF (J1, LWCO)	Occurs on opening of a low water cutoff switch connected to J11 LWCO terminals. The boiler is shut down until the fault is corrected. The display continues showing the SUPPLY, HEADER or other temperature, whichever had been selected for display. The temperature shown is the value detected at the sensor listed.	FAULT SUPPLY LOW WATER CUTOFF 168° F	Automatically resets control after temperature drops

8

Troubleshooting *(continued)*

Table 10 Status screen fault displays *(continued)*

FAULT EVENT & INTERLOCK TERMINALS	CAUSE/Discussion	DISPLAY	Action required to reset from fault
OPEN _____ SENSOR (ANY SENSOR)	<p>Occurs when the HeatNet control detects an open circuit on any sensor that should be in operation. The boiler will shut down on the failure of any sensor except the OUTDOOR sensor. If the OUTDOOR circuit is open, and the boiler is set for outdoor reset operation, the control reverts to fixed setpoint operation, controlling to either the LOCAL or SYSTEM setpoint, until the condition is corrected.</p> <p>The display continues showing the SUPPLY, HEADER or other temperature, whichever had been selected for display. The temperature shown is the value detected at the sensor listed.</p>	FAULT _____ SUPPLY OPEN _____ SENSOR 168 ° F <small>(The name of the sensor appears where the _____ is above)</small>	Automatically resets control after external limit closes
SHORTED _____ SENSOR (ANY SENSOR)	<p>Occurs when the HeatNet control detects a short circuit on any sensor that should be in operation. The boiler will shut down on the failure of any sensor except the OUTDOOR sensor. If the OUTDOOR circuit is open, and the boiler is set for outdoor reset operation, the control reverts to fixed setpoint operation, controlling to either the LOCAL or SYSTEM setpoint, until the condition is corrected.</p> <p>The display continues showing the SUPPLY, HEADER or other temperature, whichever had been selected for display. The temperature shown is the value detected at the sensor listed.</p>	FAULT _____ SUPPLY SHORTED _____ SENSOR 168 ° F <small>(The name of the sensor appears where the _____ is above)</small>	Automatically resets control after external limit closes
UV AIR SWITCH (J11B, UV SENSOR AIR SWITCH)	<p>Occurs on opening of the air proving switch connected to J11B UV SENSOR AIR SWITCH terminals.</p> <p>The air switch detects air flow across the UV sensor. The air flow is intended to reduce condensation on the UV lens assembly. This fault will not shut down the system, but does require attention to avoid nuisance problems.</p> <p>This failure is latched, causing the fault to display after the call for heat goes away.</p> <p>The display continues showing the SUPPLY, HEADER or other temperature, whichever had been selected for display. The temperature shown is the value detected at the sensor listed.</p>	FAULT _____ SUPPLY UV AIR SWITCH 168 ° F	Automatically resets control after air flow is restored; can also be reset by cycling the boiler ON/OFF switch
VAR FREQ DRIVE (J11A, VFD)	<p>Occurs when the variable frequency drive sends a fault signal to the HeatNet control VFD terminals on J11A.</p> <p>The display continues showing the SUPPLY, HEADER or other temperature, whichever had been selected for display. The temperature shown is the value detected at the sensor listed.</p>	FAULT _____ SUPPLY VAR FREQ DRIVE 168 ° F	Automatically resets control after temperature drops

8

Troubleshooting *(continued)***Table 11** Troubleshooting suggestions

Situation	Suggested procedure
Nothing happens when the power switch is turned on.	<ul style="list-style-type: none"> <input type="checkbox"/> Check 120VAC power to connection board. Verify power is connected per wiring diagrams. <input type="checkbox"/> The Power switch light (ON -Position) should illuminate if power is wired correctly. <input type="checkbox"/> If the Ignition Control is active, but the front panel display is inactive check: <ol style="list-style-type: none"> 1. Cable and cable polarity from the control board to the display. 2. Check for 120vac on the primary of the transformer and 24vac on the secondary. If one of the 24vac interlocks has been shorted to ground or the 24vac output is low, the transformer may be damaged or a 24vac circuit may be miswired. <input type="checkbox"/> The KN control is equipped with resettable fuses on the power input circuit. Wiring power incorrectly to the unit will cause these fuses to open. Once the incorrect wiring is corrected, the fuses should reset themselves in less than 5 minutes.
The display shows combustion air damper failure.	<ul style="list-style-type: none"> <input type="checkbox"/> If you are not using the combustion air damper then it needs to be disabled in the AUX FUNCTIONS menu. <input type="checkbox"/> The prove switch for the combustion air damper is not closing. Check to make sure the dampers are being controlled by the output relay you specified when programming for the damper. Also check to make sure the prove switch is working properly. <input type="checkbox"/> If these steps have been done and you continue to get the error message, check the sensor TYPE specified in the SENSORS menu. If it is set to NONE, the controller will not recognize the closed circuit. Set the Sensor type to ON/OFF.
The display is displaying random characters or the control keeps resetting.	<ul style="list-style-type: none"> <input type="checkbox"/> There may exist a grounding problem with the controller or one of the boilers, pumps, contactors or other devices connected to it. <input type="checkbox"/> If all grounding is correct, there may be an issue with radiated or induced electrical noise (interference). This may be caused by arcing across a contactor's contacts when starting a pump motor or a large electrical load. It may also be caused by the ignition transformer being improperly grounded or the spark gap being out of adjustment. <input type="checkbox"/> Attempt to identify the noise source: <ol style="list-style-type: none"> 1. What is the boiler/controller trying to do at the time of the failure? 2. Is the boiler on the same circuit as the noise source? (The boiler should have isolated power.) 3. Are shielded sensor wires used? (Ensure the shields are grounded only at the boiler control end.) 4. Are any sensors or sensor wires located near a transmitting antenna? (Move sensor)
There are no heating boilers on.	<ul style="list-style-type: none"> <input type="checkbox"/> Check the settings for OA SETPOINT and OA RESET. <ol style="list-style-type: none"> 1. If the outdoor air temperature is above the OA SETPOINT and OA RESET is on, the circulator pump relay will be locked out and the heating boilers will not fire. 2. If the water temperature is within the heating band around the setpoint, boilers will not come on. 3. The water temperature must fall below the lower band limit to begin firing boilers.
Unable to change the # of Boilers in the BOILERS menu.	<ul style="list-style-type: none"> <input type="checkbox"/> In H-Net method, the KN control auto-detects the boilers in the system and adjusts the number of boilers accordingly. <input type="checkbox"/> Using H-NET, if the number of boilers is not being detected properly as the actual number of boilers in the system, check each boiler. There can only be (1) master boiler, but there can be up to 15 member boilers. <input type="checkbox"/> Make sure only the master boiler has a Header Sensor (SYS/DHW HEADER) connected. <input type="checkbox"/> Verify that each boiler's HeatNet cable is in place. <input type="checkbox"/> Verify that each boiler has a unique address assigned (ADVANCED SETUP DISTRIBUTED CTRL H-NET ADDRESS).

8

Troubleshooting *(continued)***Table 11** Troubleshooting suggestions *(continued)*

Situation	Suggested procedure
The BOILERS menu only indicates one boiler, but there are member boilers connected. The amber light blinks on all of the boilers communications jacks.	<ul style="list-style-type: none"> <input type="checkbox"/> Verify that the latest version of firmware is installed on all boilers. <input type="checkbox"/> All boilers in a system must have the same firmware revision (version). <input type="checkbox"/> Verify the proper termination is set on the Master and the last Member boiler.
H-Net boilers are detected but then lost and then detected again.	<ul style="list-style-type: none"> <input type="checkbox"/> The H-Net communications cable may be receiving interference from the blower, ignition, or other form of radiated electrical noise. <input type="checkbox"/> Termination of the jumpers may not be correct or there is more than one master. <ol style="list-style-type: none"> 1. Ensure that the termination dip switches are set on the MASTER boiler and only the LAST MEMBER boiler. All of the other member boilers should have their termination dip switches OFF. 2. There may be two or more MASTER boilers. Ensure that only one header sensor is present and connected to the SYS/DHW HEADER input. There should be no wires or sensors connected to the SYS/DHW HEADER input if the boiler is operating as a member. 3. Verify that the HNet cables are of a shielded or twisted pair type. Shielding of the cable is required. 4. Minimize possible electrical interference by routing the communications cables away from electrical noise sources, such as motors, ignition controls, contactors, etc.
Only the MASTER boiler Fires, but the system has many boilers and is using H-Net.	<ul style="list-style-type: none"> <input type="checkbox"/> In order for the MASTER boiler to act as a MASTER, the header sensor must be set to TYPEZ, and there must be a header sensor present. <input type="checkbox"/> At power-up, the header sensor is auto detected. If the temperature of the header sensor at power-up is greater than -25 °F and less than 240 °F it is considered a valid sensor. The boiler will default to the MEMBER mode if the temperature is not in this range, and can only be run locally or by external inputs. <input type="checkbox"/> The HNet needs a communications cable daisy-chained between boilers. Ensure that a good connection is made on the communications board and that the lights on the dual RJ45 jacks flash (roughly twice a second). The MASTER is the only one that should flash with no communications cables plugged in.
You get the error message – WATER FLOW SWITCH or WAITING FOR FLOW.	<ul style="list-style-type: none"> <input type="checkbox"/> If the control does not sense a closed circuit at input connection, FLOW SWITCH, check to make sure the circuit for the circulator pump is correct, that the pump is being energized, and that the flow prove switch is working properly. <input type="checkbox"/> If there is no flow prove switch, check to make sure that a jumper wire has been connected across the FLOW SWITCH terminals.
You have forgotten the password.	<ul style="list-style-type: none"> <input type="checkbox"/> Turn the ON/OFF switch off. Then depress and hold the ESC key while turning it back on. This will load the default password “AAAAAA”.
Firmware update program starts to load, but then stops.	<ul style="list-style-type: none"> <input type="checkbox"/> Ensure that the USB driver for your PC/Laptop computer is properly installed.

8

Troubleshooting *(continued)***Table 11** Troubleshooting suggestions *(continued)*

Situation	Suggested procedure
H-Net boilers are detected but then lost and then detected again.	<ul style="list-style-type: none"> <input type="checkbox"/> The H-Net communications cable may be receiving interference from the blower, ignition, or other forms of radiated electrical noise. <input type="checkbox"/> Termination of the jumpers may not be correct or there is more than one master. <ol style="list-style-type: none"> 1. Ensure that the termination dip switches are set on the MASTER boiler and only the LAST MEMBER boiler. All of the other member boilers should have their termination dip switches OFF. 2. There may be two or more MASTER boilers. Ensure that only one header sensor is present and connected to the HEADER input. There should be no wires or sensors connected to the HEADER input if the boiler is operating as a member. 3. Verify that the HNet cables are of a shielded or twisted pair type. Shielding of the cable is required. 4. Minimize possible electrical interference by routing the communications cables away from electrical noise sources, such as motors, ignition controls, contactors, etc.
Only the MASTER boiler Fires, but the system has many boilers and is using H-Net.	<ul style="list-style-type: none"> <input type="checkbox"/> In order for the MASTER boiler to act as a MASTER, the header sensor must be set to TYPEZ, and there must be a header sensor present. <input type="checkbox"/> At power-up, the header sensor is auto detected. If the temperature of the header sensor at power-up is greater than –25 °F and less than 240 °F it is considered a valid sensor. The boiler will default to the MEMBER mode if the temperature is not in this range, and can only be run locally or by external inputs. <input type="checkbox"/> The HNet needs a communications cable daisy-chained between boilers. Ensure that a good connection is made on the communications board and that the lights on the dual RJ45 jacks flash (roughly twice a second). The MASTER is the only one that should flash with no communications cables plugged in.
You get the error message – WATER FLOW SWITCH or WAITING FOR FLOW.	<ul style="list-style-type: none"> <input type="checkbox"/> If the control does not sense a closed circuit at input connection, FLOW SWITCH, check to make sure the circuit for the circulator pump is correct, that the pump is being energized, and that the flow prove switch is working properly. <input type="checkbox"/> If there is no flow prove switch, check to make sure that a jumper wire has been connected across the FLOW SWITCH terminals.
You have forgotten the password.	<ul style="list-style-type: none"> <input type="checkbox"/> Turn the ON/OFF switch off. Then depress and hold the ESC key while turning it back on. This will load the default password “AAAAAA”.
Firmware update program starts to load, but then stops.	<ul style="list-style-type: none"> <input type="checkbox"/> Ensure that the USB driver for your PC/Laptop computer is properly installed.

9

Setup worksheet *(record all parameters here)*

SETUP MENU		
Menu item	Default	Value
BOILERS		
# OF BOILERS		
LEAD BOILER #	1	
HEAT BAND	30°F	
SETPOINTS		
LOCAL SETPOINT	180°F	
OPERATE LIMIT	205°F	
OP LIM BAND	10°F	
SETPOINT SOURCE	AUTO	
OUTDOOR AIR RESET		
OA RESET	OFF	
OA SETPOINT	68°F	
OVERRIDE RESET	NO	
SET OA SETPOINTS		
WATER TEMP AT HIGH OA TEMP	140°F	
	70°F	
WATER TEMP AT LOW OA TEMP	180°F	
	10°F	
PUMP OPTIONS		
SYSTEM PUMP		
POST PURGE TIME	2 minutes	
ALWAYS ENABLED	OFF	

SUMMER PUMP JOG	OFF	
LOCAL PUMP		
DELTA TEMP ENAB	OFF	
DELTA TEMP	10°F	
POST PRGE TIME	2 minutes	
ALWAYS ENABLED	OFF	
PUMP/VALVE OPTION		
REMAINS ON:	OFF	
FLOW PROVE	10 seconds	
NIGHT SETBACK		
SETBACK ENTRY	1	
ENTRY IS		
SETBACK		
SETBACK TIME		
START DAY		
TIME		
END DAY		
TIME		
SETBACK ENTRY	2	
ENTRY IS		
SETBACK		
SETBACK TIME		
START DAY		
TIME		
END DAY		
TIME		

9

Setup worksheet (record all parameters here) (continued)

SETBACK ENTRY	3	
ENTRY IS		
SETBACK		
SETBACK TIME		
START DAY		
TIME		
END DAY		
TIME		
SETBACK ENTRY	4	
ENTRY IS		
SETBACK		
SETBACK TIME		
START DAY		
TIME		
END DAY		
TIME		
OPTIONS		
TEMP SCALE	°F	
KEY CLICK	ON	
SKIP PASSWORD	ON	
BRIGHTNESS	50%	
LOG/ RUNTIME		
RUN HOURS		
DATA LOG ENTRY		
SIZE		
BOILER CYCLES		

AUX FUNCTIONS		
COMBUST AIR DAMPER		
IN USE?	NO	
OUTPUT RELAY #	J10B DAMPER	
PROOF TIME		
ALARM SILENCE		
ALARM SILENCE IN USE?	YES	
INPUT=	J10B SPARE 2	
FAILSAFE MODES		
RUN IN LOCAL IF:		
H-NET COMM LOST:	ON	
LOW TEMP:	OFF	
TEMP LESS THAN	40°F	
SYSTEM CLOCK	Verified/updated? _____	

ADVANCED SETUP MENU

Menu item	Default	Value
DISTRIBUTED CTRL		
CONTROL	H-NET	
H-NET MASTER	YES	
LOCAL ADDRESS	255	
CONSOLE ADDRESS	1	

9

Setup worksheet (record all parameters here) (continued)

MODULAR BOILER SET		
ADD BOILER DELAY	10 MINUTES 0 SECONDS	MINUTES SECONDS
SHED BOILER DELAY	2 MINUTES 0 SECONDS	MINUTES SECONDS
MODULATE DELAY TIME	0 MINUTES 10 SECONDS	MINUTES SECONDS
MOD MAX – LAST FIRE	50%	
STOP BAND OFFSET	5°F	
BOILER START TIME	50 seconds	
MODULATION PID		
Factory set — not adjustable		
FIRING MODE		
FIRING MODE	TRUE ROTATION	
MASTER FIRST	OFF	
SENSORS		
SENSOR #	OUTSIDE	
TYPE	TYPE Z	
CALIBRATED?		
SENSOR #	SUPPLY	
TYPE	TYPE Z	
CALIBRATED?		
SENSOR #	RETURN	
TYPE	TYPE Z	
CALIBRATED?		

SENSOR #	HEADER	
TYPE	TYPE Z	
CALIBRATED?		
SENSOR #	5	
TYPE	TYPE Z	
CALIBRATED?		
SENSOR #	6	
TYPE	TYPE Z	
CALIBRATED?		
4-20MA INPUT		
4MA SETPOINT	50°F	
20MA SETPOINT	220°F	
BOILER START	4.11 MA	
PASSWORD		
PASSWORD	AAAAAA	
COMMUNICATIONS		
BAUD	19200	
PARITY	EVEN	
MODEM INSTALLED	NO	
LOAD DEFAULTS		
Defaults loaded?		
SYSTEM		
Factory test run?		
Firmware loaded?		

10

Control specifications



Control	Microprocessor based PID modulating control (NOT a safety limit)
Environment	-40 F to 140 F < 90% RH non-condensing
Input Power	24 VAC, 250 ma
Switched Line	KN-6, KN-10 — 120 VAC single phase OR — 208/230/240 VAC/1/60 (with neutral)
	KN-20 — 208/230/240 VAC/1/60 (with neutral)
Relays	Stage, Circulator, Alarm 8A 250 VAC
AC Interlocks	24 VAC – 120 VAC input
Control Inputs	AA, Heat Demand, 4-20ma Enable, OA override, T1-T2 (dry contact inputs)
Dimensions	9" wide: 6" high : 2" deep
Temperature Sensors	NTC thermistor, 10K @ 77 F, 335.67K @ -40 F, 185 @ 150 F , +/- 1 F
Environment	-40 F to 140 F < 90% RH non-condensing
USB	1.0
RS485 Console	Modbus RTU, 9600 baud, 8 bits, Even Parity, 1 Stop Bit
Boiler-to-Boiler	Heat Net (H-Net)
Network	Optional LonWorks, BACnet available

HydroTherm[®]

A Product of

Advanced Thermal Hydronics



A MESTEK COMPANY

260 North Elm Street, Westfield, MA 01085

Tel: (413) 564-5515 • Fax: (413) 568-9613

7555 Tranmere Drive, Mississauga, ONT. L5S 1L4 Canada

Tel: (905) 672-2991 • Fax: (905) 672-2883

www.hydrotherm.com